

Renewal Parts for DB Circuit Breakers

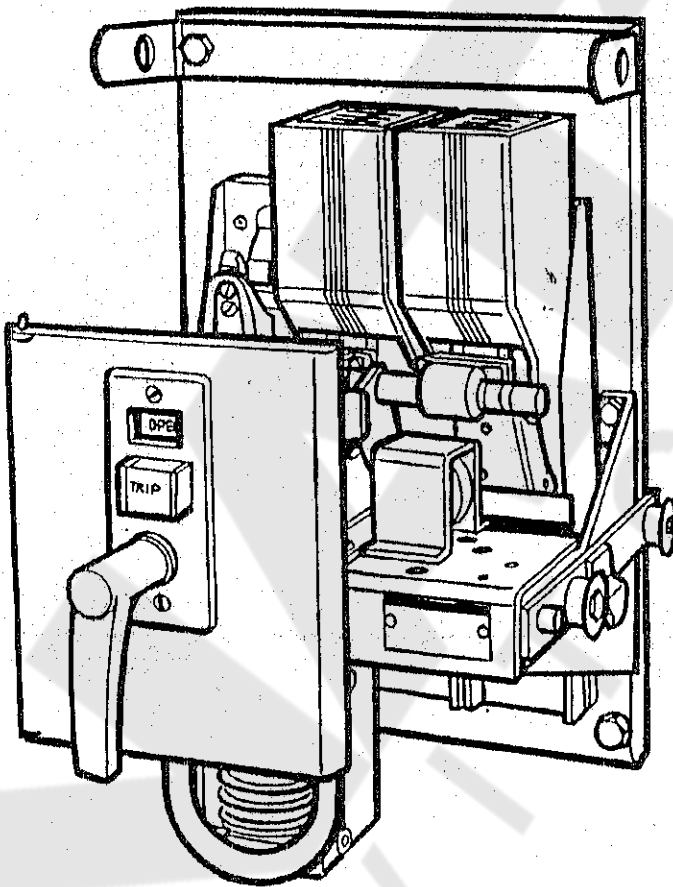

DB-25 Front View

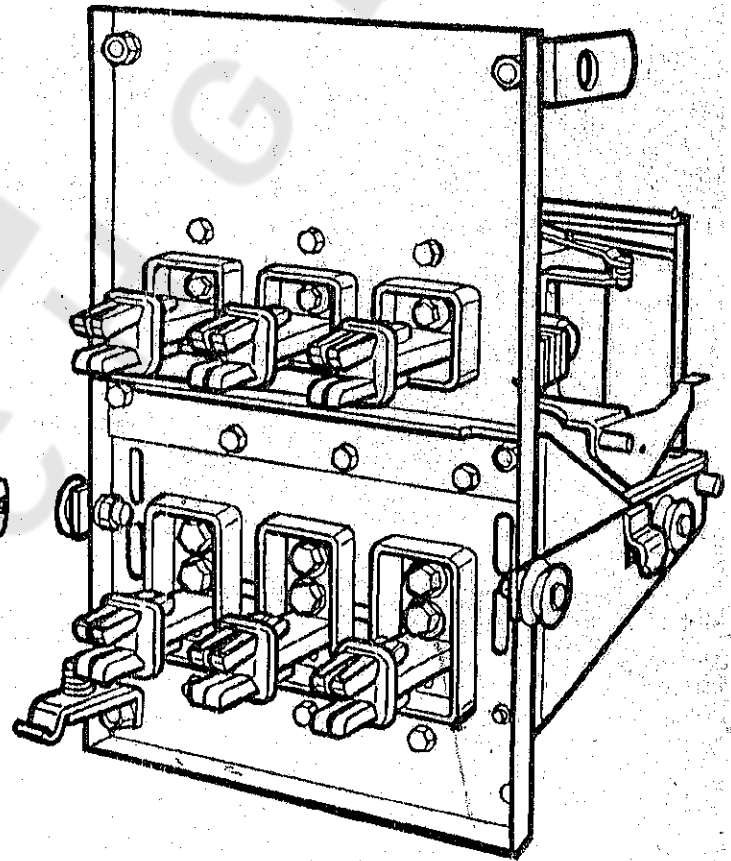

DB-25 Back View

NATIONAL SWITCHGEARTM

Contents

Arc Chutes	3
Auxiliary Switches	4
Secondary Contact	4
Closing Coils	8
Cell Parts	8
Connection Studs	2
Control Relays	7
Finger Clusters	2
Main Contact	9
Cell Parts	9
Secondary Contact	9
Moulded Contact Base	8
Cell Parts	8
Moving Arcing Contact	1
Moving Main Contact	1
Operating Handle	3
Operating Link	2
Operating Mechanism	3
Pole Unit	1
Shunt Trip Coils	5
Shunt Trip Devices	5
Stationary Arcing Contact	2
Stationary Main Contact	1
Toggle Levers	4
Undervoltage Trip Coils	6
Undervoltage Trip Devices	6

Description	Part No.	Qty./Bkr.	Unit Price
-------------	----------	-----------	------------

Pole Unit

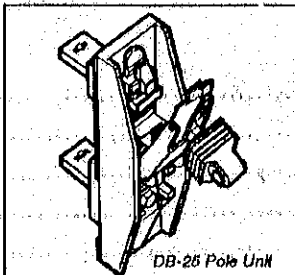

DB-15 Pole Unit	1529684	3	
DB-25 Pole Unit	1529382	3	
DB-50 Pole Unit	28A2190G06	3	
DB-75 Pole Unit	406D445G01	3	
DB-100 Pole Unit	405D391G01	3	

Apply multiplier "B"

Moving Main Contact

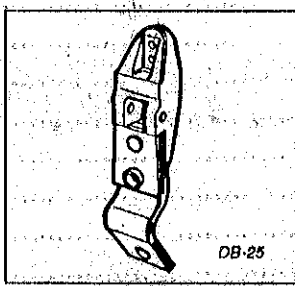

DB-15 Moving main contact with shunt	1529156	3	
DB-25 Moving main contact with shunt	18A9894G03	3	
DB-50 Moving main contact with shunt	200B570G01	3	
DB-75 Moving main contact	406D443G01	3	
DB-100 Moving main contact	405D390G01	3	

Apply multiplier "B"

Moving Arcing Contact

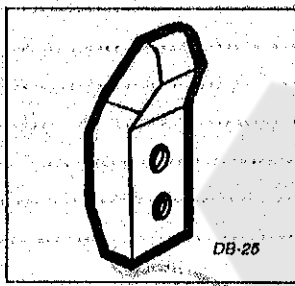

DB-15 Moving arcing contact	1529200	3	
DB-25 Moving arcing contact	18A9894G01	3	
DB-50 Moving arcing contact	309C855G01	3	
DB-75 Moving arcing contact	302C062G01	3	
DB-100 Moving arcing contact	201B184G01	3	

Apply multiplier "B"

Stationary Main Contact

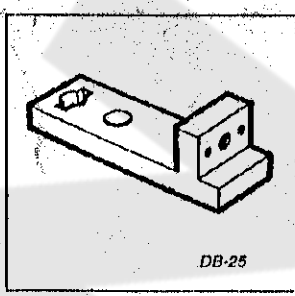

DB-15 Stationary main contact including arcing contact	1529201	3	
DB-25 Stationary main contact including upper stud	21A3598G01	3	
DB-50 Stationary main contact including upper stud	1611764	3	
DB-75 Upper stationary main contact fingers	1809167	12	
Lower stationary main contact fingers	1799915	12	
Hinge contact fingers	1799912	24	
DB-100 Upper stationary main contact fingers	1809167	15	
Lower stationary main contact fingers	1799915	15	
Hinge contact fingers	1799912	24	

Apply multiplier "B"

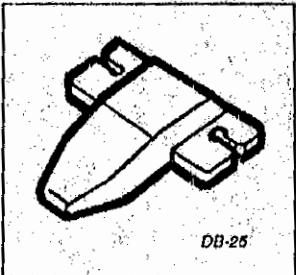
	Description	Part No.	Qty./Bkr.	Unit Price
Stationary Arcing Contact				
	DB-15 Stationary arcing contact including main contact	1529201	3	
	DB-25 Stationary arcing contact	21A3598G02	3	
	DB-50 Stationary arcing contact	1611748	3	
	DB-75 Stationary arcing contact	302C063G01	3	
	DB-100 Stationary arcing contact	301C700G01	3	
	Apply multiplier "B"			

Connection Studs

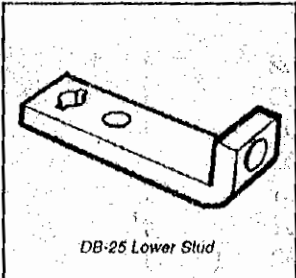
	DB-15 Upper Stud	1529195	3	
	DB-15 Lower Stud	1735837	3	
	DB-25 Upper Stud including stationary main contact	21A3598G01	3	
	DB-25 Lower Stud	1735836	3	
	DB-50 Upper Stud including stationary main contact	1611764	3	
	DB-50 Lower Stud	1611767	3	
	DB-75 Upper Stud assembly	406D445G02	3	
	DB-75 Lower Stud assembly	406D445G03	3	
	DB-100 Upper Stud assembly	40A8617G02	3	
	Apply multiplier "B"			

Operating Link

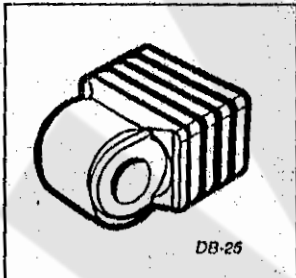
	DB-15 Operating Link	6C1093G01	3	
	DB-25 Operating Link	1491410	3	
	DB-50 Operating Link	1611758	3	
	DB-75 Operating Link	21C5415G03	3	
	DB-100 Operating Link	21C5415G03	3	
	Apply multiplier "B"			

Finger Clusters

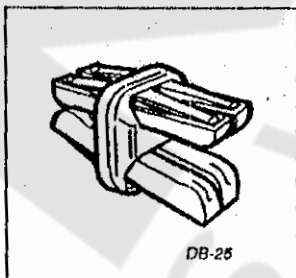
	DB-15 Finger Cluster	1491905	6	
	DB-25 Finger Cluster	1491904	6	
	DB-50 Finger Cluster	679C711G08	6	
	DB-75 Finger Cluster	679C711G08	12	
	DB-100 Finger Cluster	679C711G03	12	
	Apply multiplier "B"			

Arc Chutes

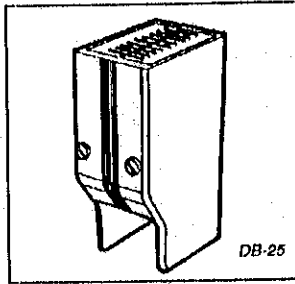

DB-15	Arc chute	1406222	3
DB-25	Arc chute	1491059	3
DB-50	Arc chute	1611017	3
DB-75	Arc chute	405D389G04	3
DB-100	Arc chute	405D389G04	3

Apply multiplier "B"

Operating Mechanism

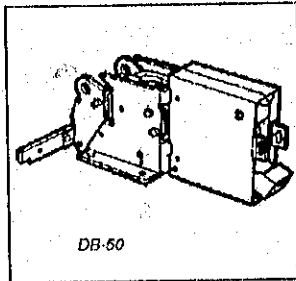

3 Position

DB-15	Electric	420D494G02	1
	Manual	420D494G03	1
DB-25	Electric	419D872G01	1
	Manual	419D872G03	1
DB-50	Electric	418D904G01	1
	Manual	418D623G01	1
DB-75	Electric	410D348G02	1
DB-100	Electric	410D348G03	1

1 Position

DB-15	Electric	420D493G02	1
	Manual	420D493G04	1
DB-25	Electric	419D870G03	1
	Manual	419D870G04	1
DB-50	Electric	418D902G03	1
	Manual	418D622G03	1
DB-75	Electric	44A9415G06	1
DB-100	Electric	44A9415G05	1

Apply multiplier "B"

Operating Handle

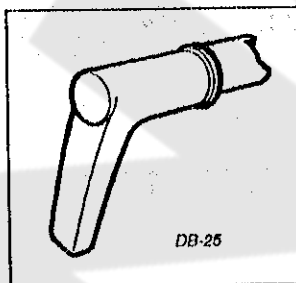

DB-15	Handle	302C425G02	1
	1 Pos - Rotary Close & Trip	13B4832H04	1
DB-25	Handle	302C425G02	1
	1 Pos - Rotary Close & Trip	13B4832H04	1
DB-50	Handle	302C426G02	1
DB-75	Handle	127A158H01	1
DB-100	Handle	127A158H01	1

Apply multiplier "B"

Description	Part No.	Qty./Bkr.	Unit Price
-------------	----------	-----------	------------

Auxiliary Switches

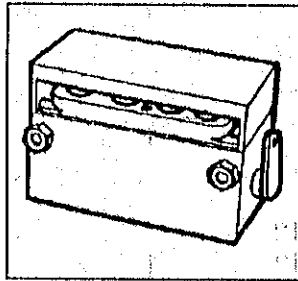

DB-15	4 Pole D.O. Switch	13B4492G06	1
	8 Pole D.O. Switch	18B4492G07	1
DB-25	4 Pole D.O. Switch	14B7132G06	1
	8 Pole D.O. Switch	14B7132G07	1
DB-50	4 Pole D.O. Switch	20B8346G07	1
	8 Pole D.O. Switch	20B8346G08	1
DB-75	4 Pole D.O. Switch	20B8346G07	1
	8 Pole D.O. Switch	20B8346G08	1
DB-100	4 Pole D.O. Switch	20B8346G07	1
	8 Pole D.O. Switch	20B8346G08	1

Secondary Contact

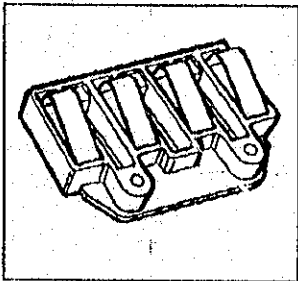

DB-15	Secondary Contact (4P)	18B1225G09	1
DB-25	Secondary Contact (4P)	18B1225G09	1
DB-50	Secondary Contact (4P)	18B1225G09	1
DB-75	Secondary Contact (4P)	18B1225G09	1
DB-100	Secondary Contact (4P)	18B1225G09	1

Apply multiplier "B"

Toggle Levers

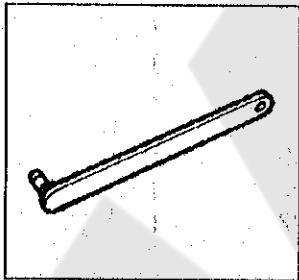

DB-15	First	405D799H09	1
	Second	1406238	1
	Third	1406237	1
DB-25	First	419D395H11	1
	Second	1491458	1
	Third	1491463	1
DB-50	<i>Electric</i>		
	First	308C399H01	1
	Second	1589676	1
	Third	1589677	1
	<i>Manual</i>		
	First	309C114H01	1
DB-75	Second	1589676	1
	Third	1589677	1
	First	1589675	1
DB-100	Second	1799907	1
	Third	1799884	1
	First	1589675	1
DB-100	Second	1799907	1
	Third	1799884	1
	First	1589675	1

Apply multiplier "B"

Shunt Trip Devices

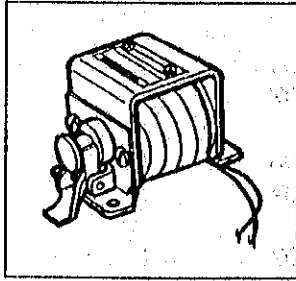

DB-15	48V DC / 120V AC	1491361	1	
	125V DC / 240V AC and Capacitor trip	1491362	1	
	DB-25	48V DC / 120V AC	1491361	1
		125V DC / 240V AC and Capacitor trip	1491362	1
	DB-50	48V DC / 120V AC	309C012G12	1
		125V DC / 240V AC and Capacitor trip	309C012G12	1
DB-75	48V DC / 120V AC	309C012G12	1	
	125V DC / 240V AC and Capacitor trip	309C012G12	1	
DB-100	48V DC / 120V AC	309C012G12	1	
	125V DC / 240V AC and Capacitor trip	309C012G12	1	

Apply multiplier "B"

Shunt Trip Coils

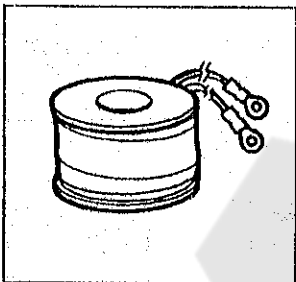

DB-15	115V AC, 60 Hz	157A583	1
	220V AC, 60 Hz	1491403	1
	125V DC	1491403	1
	250V DC	1491404	1
DB-25	115V AC, 60 Hz	157A583	1
	220V AC, 60 Hz	1491403	1
	125V DC	1491403	1
	250V DC	1491404	1
DB-50	115V AC, 60 Hz	677C903G06	1
	220V AC, 60 Hz	677C903G07	1
	125V DC	677C903G07	1
	250V DC	1491404	1
DB-75	115V AC, 60 Hz	1574583	1
	220V AC, 60 Hz	1491403	1
	125V DC	1491403	1
	250V DC	1491404	1
DB-100	115V AC, 60 Hz	677C903G05	1
	220V AC, 60 Hz	1491403	1
	125V DC	1491403	1
	250V DC	1491404	1

Apply multiplier "B"

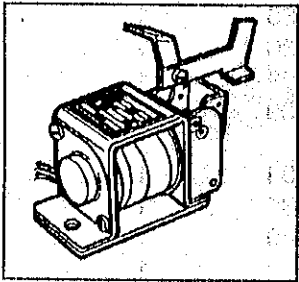
	Description	Part No.	Qty./Bkr.	Unit Price
Undervoltage Trip Devices				
	DB-15	125V DC	23A9019G31	1
		120V AC	23A9019G33	1
	DB-25	125V DC	23A9019G31	1
		120V AC	23A9019G33	1
	DB-50	48V DC	23A9019G75	1
		125V DC	23A9019G61	1
		120V AC	23A9019G63	1
	DB-75	125V DC	23A9019G68	1
		120V AC	23A9019G70	1
	DB-100	125V DC	23A9019G68	1
		120V AC	23A9019G70	1

Apply multiplier "B"

Undervoltage Trip Coils

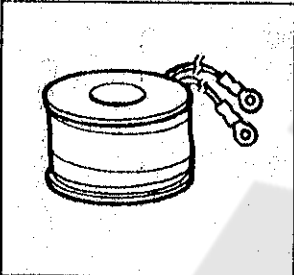
	DB-15	120V AC	1491403	1
		220V AC / 48V DC	1491404	1
		250V DC	1529248	1
		125V DC / 440V AC	1611027	1
	DB-25	120V AC	1491403	1
		220V AC / 48V DC	1491404	1
		250V DC	1529248	1
		125V DC / 440V AC	1611027	1
	DB-50	120V AC	1491403	1
		220V AC / 48V DC	1491404	1
		250V DC	1529248	1
		125V DC / 440V AC	1611027	1
	DB-75	120V AC	1491403	1
		220V AC / 48V DC	1491404	1
		250V DC	1529248	1
		125V DC / 440V AC	1611027	1
	DB-100	120V AC	1491403	1
		220V AC / 48V DC	1491404	1
		250V DC	1529248	1
		125V DC / 440V AC	1611027	1

NOTE: All style numbers shown are for undervoltage with instantaneous trip. For time delay trip, order part number 1533717 in addition to the above styles.

Apply multiplier "B"

Control Relays

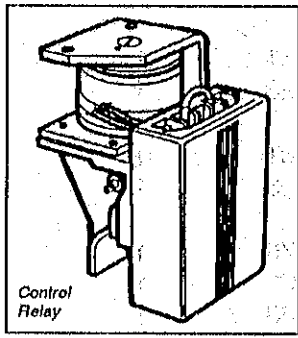

DB-15	115V AC, 60 Hz	33A2746G34	1
	220V AC, 60 Hz	33A2746G35	1
	440V AC, 60 Hz	33A2746G36	1
	125V DC	33A2746G32	1
	250V DC	33A2746G33	1
DB-25	115V AC, 60 Hz	33A2746G34	1
	220V AC, 60 Hz	33A2746G35	1
	440V AC, 60 Hz	33A2746G36	1
	125V DC	33A2746G32	1
	250V DC	33A2746G33	1

DB-50, DB-75, DB-100

115V AC, 60 Hz	Standard Burden Coil	33A2746G34	1
	Heavy Burden Coil	60A1412G27	1
220V AC, 60 Hz	Standard Burden Coil	33A2746G35	1
	Heavy Burden Coil	60A1412G28	1
440V AC, 60 Hz	Standard Burden Coil	33A2746G36	1
	Heavy Burden Coil	60A1412G29	1
125V DC	Standard Burden Coil	33A2746G32	1
	Heavy Burden Coil	1802990	1
250V DC	Standard Burden Coil	33A2746G33	1
	Heavy Burden Coil	1802991	1
Cover for all x-relays		1491301	
X-Relay Blowout Coil		1589340	
X-Relay Contacts:			
R.H. Stationary Contacts		1491295	
Moving Contacts		1491294	
L.H. Stationary Contacts		23A3609G17	

Apply multiplier "B"

Description	Part No.	Qty./Bkr.	Unit Price
-------------	----------	-----------	------------

Closing Coils

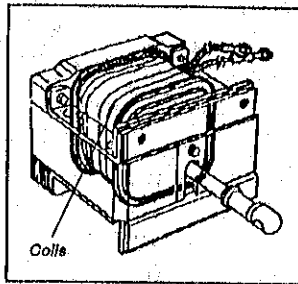

DB-15	440V AC	300P516G01	1
	220V AC	300P747G01	1
	115V AC	300P748G01	1
	125V DC	1529691	1
	250V DC	1535307	1
DB-25	440V AC	300P167G01	1
	220V AC	300P166G01	1
	115V AC	1529458 ¹	1
	125V DC	1529458	1
	250V DC	1718045	1
DB-50	440V AC	1736187 ³	1
	220V AC	1615364 ²	1
	115V AC	1736658 ⁴	1
	125V DC	300P606G01	1
	250V DC	1718483	1
DB-75	440V AC	300P834G01 ³	1
	220V AC	300P268G01 ²	1
	115V AC	1809520 ⁵	1
	125V DC	1809520	1
	250V DC	300P268G01	1
DB-100	440V AC	300P834G01 ³	1
	220V AC	300P268G01 ²	1
	115V AC	1809520 ⁵	1
	125V DC	1809520	1
	250V DC	300P268G01	1

- ¹ Use with rectifier style number 685C694G01
- ² Use with rectifier style number 685C694G02
- ³ Use with rectifier style number 685C694G03
- ⁴ Use with rectifier style number 685C694G04
- ⁵ Use with rectifier style number 685C694G05

Apply multiplier "B"

Cell Parts

Moulded Contact Base

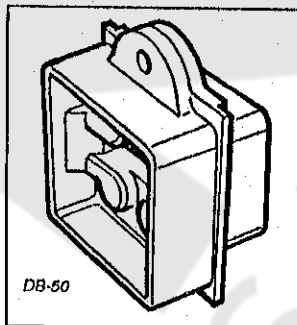

DB-15	Moulded Contact Base	1615701	6
DB-25	Moulded Contact Base	1615701	6
DB-50	Moulded Contact Base	1611881	6
DB-75	Moulded Contact Base	1810282	6
DB-100	Moulded Contact Base	1810282	6

Apply multiplier "B"

Cell Parts

Main Contact

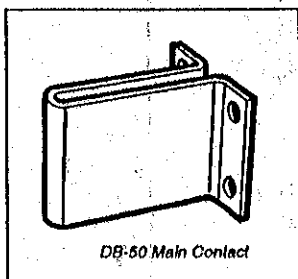

DB-15	Main Contact	1615590	6
DB-25	Main Contact	1615590	6
DB-50	Main Contact	1611882	6
DB-75	Main Contact	1810289	12
	Spacer	1810291	6
	Spacer	29D0888H44	24

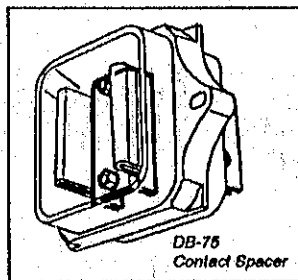

DB-100	Main Contact	1810290	12
	Spacer	1810291	6
	Spacer	29D0888H44	24

Apply multiplier "B"

Cell Parts

Secondary Contact

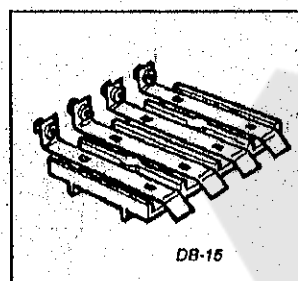

DB-15	Secondary Contact	18B1225G10	1
DB-25	Secondary Contact	18B1225G10	1
DB-50	Secondary Contact	18B1225G10	1
DB-75	Secondary Contact	18B1225G10	1
DB-100	Secondary Contact	18B1225G10	1

Apply multiplier "B"

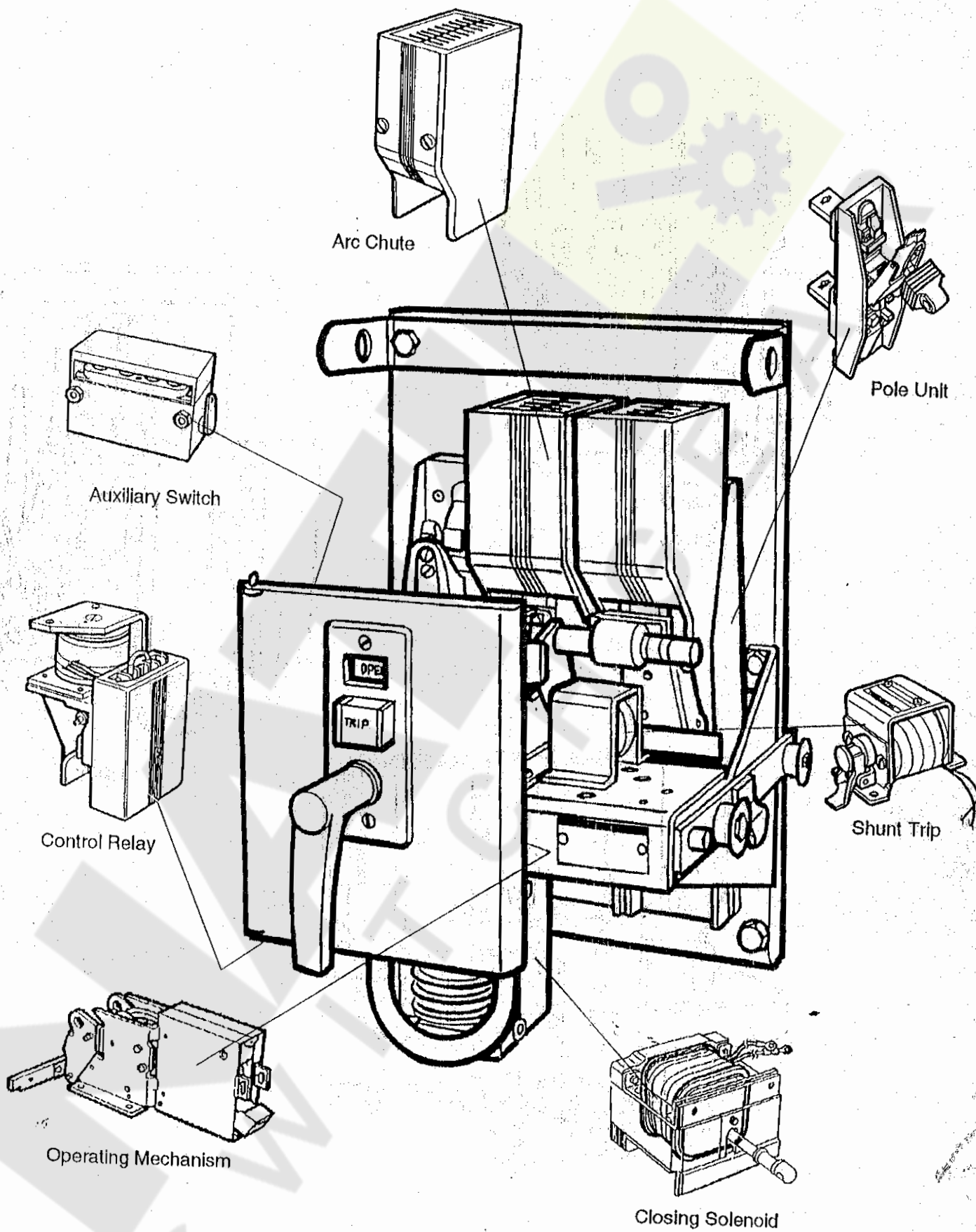

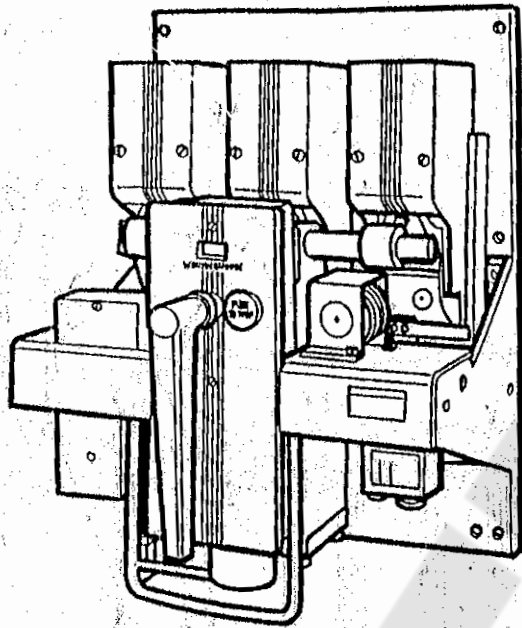

DB-50

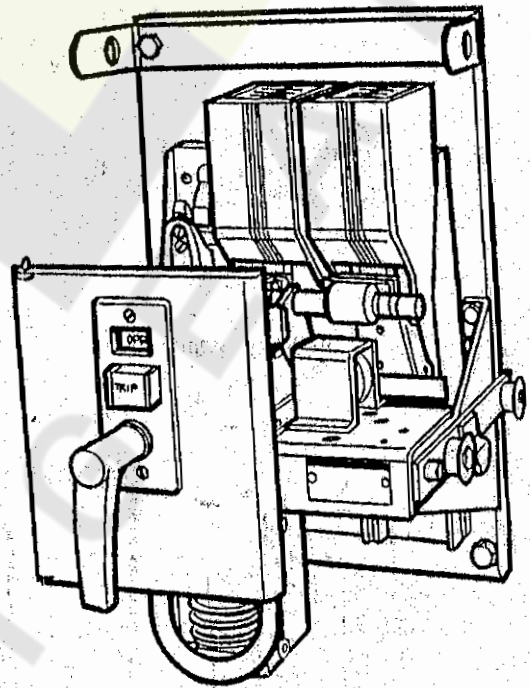

DB-25

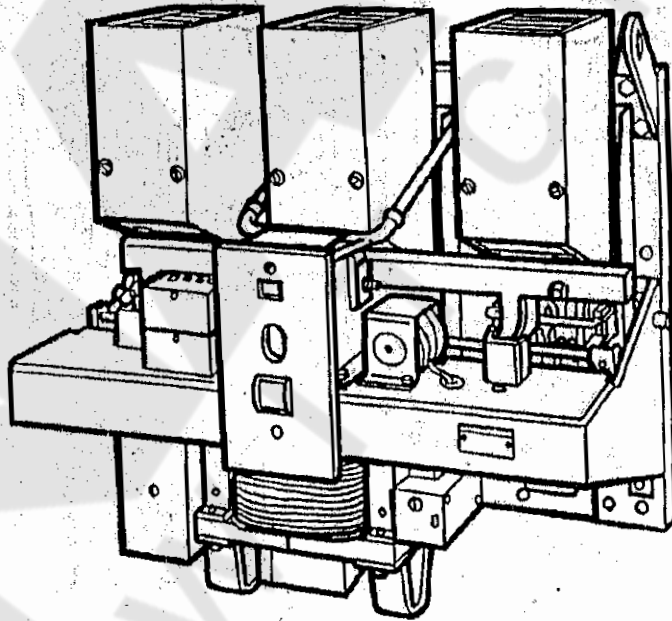

DB-75