



# Power Break® II Circuit Breaker Accessories

## Key Interlock Mounting Provision

### Introduction

The Key Interlock Mounting Provision, shown in Figure 1, can be installed on 800–4000 ampere frame Power Break® II circuit breakers. A single lock body with one to four key-lock cylinders can be installed. The GE catalog number is SPK4.

The key lock must have a zero extension when the bolt is withdrawn with 0.75-inch extension when the bolt is extended. The lock may be up to 1.50 inch wide. Catalog numbers for suitable locks from ABB-Kirk® and Superior Interlock Co. are listed in Table 1.

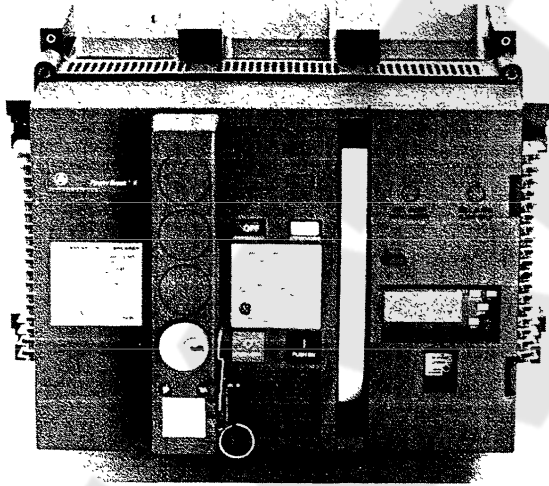

Figure 1. The Key Interlock mounted on a circuit breaker.

# Locks	ABB-Kirk® Cat. No.	Superior Cat. No.	Approx. Lock Length
1	KFN00001 <sub>1</sub>	S105827Y	2.38"
2	KFN00002 <sub>1</sub>	S105828Y	3.38"
3	KFN00003 <sub>1</sub>	S105829Y	4.38"
4	KFN00004 <sub>1</sub>	S105827-4Y	5.48"

<sup>1</sup> Final digit may be 0, 1, 2, or 3 depending on key removable positions.

Table 1. Catalog numbers of suitable Key Interlock models.

### Operation

The Key Interlock prevents the breaker from closing by holding the padlock hasp extended, thus keeping the trip latch in the tripped position. A secondary padlock lever is included with the Key Interlock, since the Key Interlock blocks easy access to the standard padlock hasp. To operate, use the following procedure:

1. Trip the breaker (press the OFF button).
2. Grasp the ring to pull out the nylon-coated padlock hasp. Note that if the breaker contacts are closed, the padlock hasp will not pull out. Do not exceed 10 lb pulling force on the ring.
3. Turn the key, securing the padlock hasp in the extended position, as illustrated in Figure 2. The breaker cannot be closed until the Key Interlock is disengaged.
4. Rotate the secondary padlock lever out and attach padlocks, if desired, as illustrated in Figure 3.

**CAUTION:** Repeated attempts to close a locked-out circuit breaker will damage the breaker mechanism.

**ATTENTION:** Les tentatives à maintes fermer un disjoncteur verrouillé en position "ouvert" endommageront le mécanisme de disjoncteur.

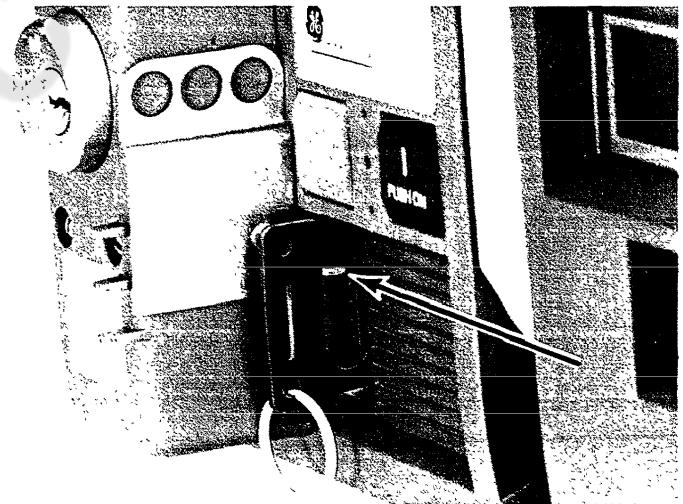

Figure 2. View of the breaker, showing the padlock hasp held extended by the Key Interlock.

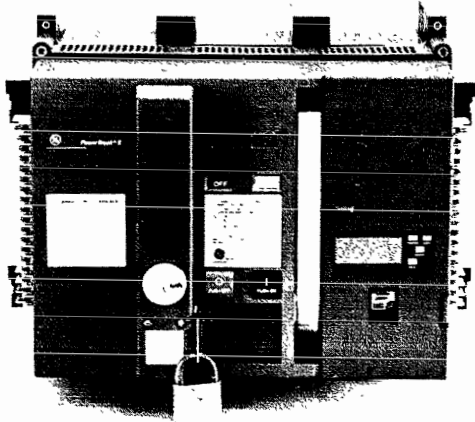

Figure 3. The Key Interlock with a padlock attached.

## Installation

**WARNING:** Before installing any accessories, turn the breaker off, disconnect it from all voltage sources, and discharge the closing springs.

**AVERTISSEMENT:** Avant d'installer tout accessoire, mettre le disjoncteur en position OFF, le déconnecter de toute tension d'alimentation, et décharger les ressorts d'armement.

Use the following procedure to install the Key Interlock Mounting Provision. Figure 4 is an exploded view of the installation.

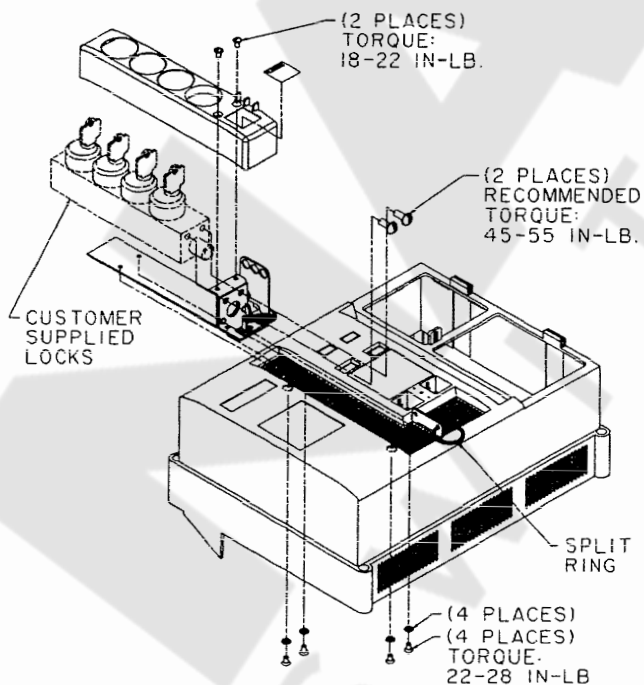

Figure 4. Exploded view of the Key Interlock Mounting Provision installation.

1. If a trim plate is installed on the breaker, loosen the four screws securing the trim-plate assembly and remove the trim plate from the breaker.
2. Loosen the four screws at the corners of the breaker cover. Remove the cover from the breaker face.
3. Drill four  $1\frac{5}{64}$ -inch (0.234 inch) holes through the cover, as shown in Figure 5.

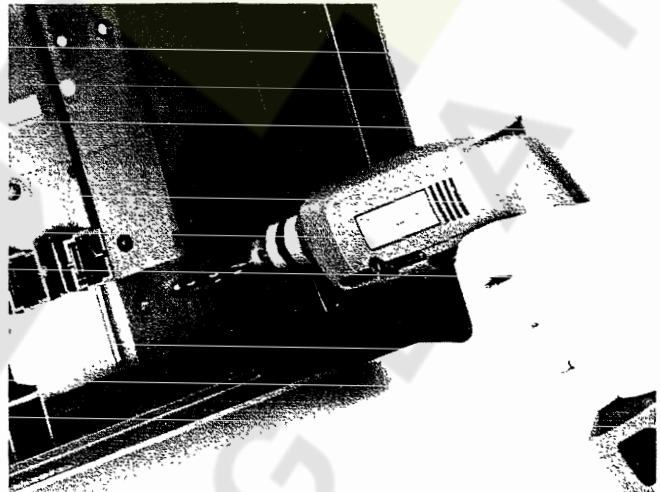

Figure 5. The inside of the breaker cover, showing the mounting holes being drilled.

4. Mount the lock mounting plate to the cover, as shown in Figure 6, with four #8-32 flathead screws and lock washers.

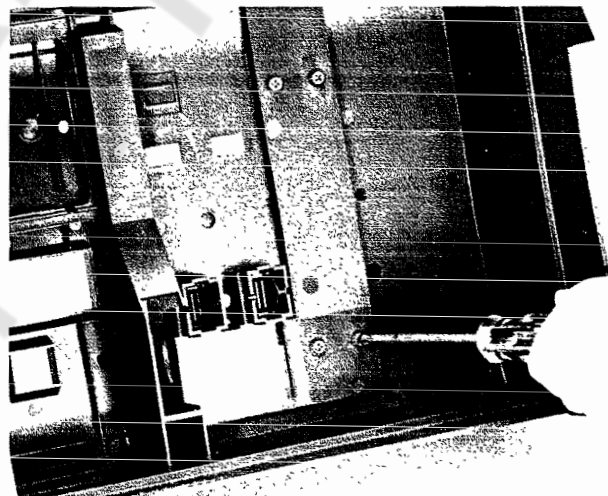

Figure 6. The inside of the breaker cover, showing the screws being attached to the Key Interlock mounting plate.

5. Attach the Key Interlock body to the mounting plate with two  $\frac{1}{4}$ -20 screws and lock washers, as shown in Figure 7.

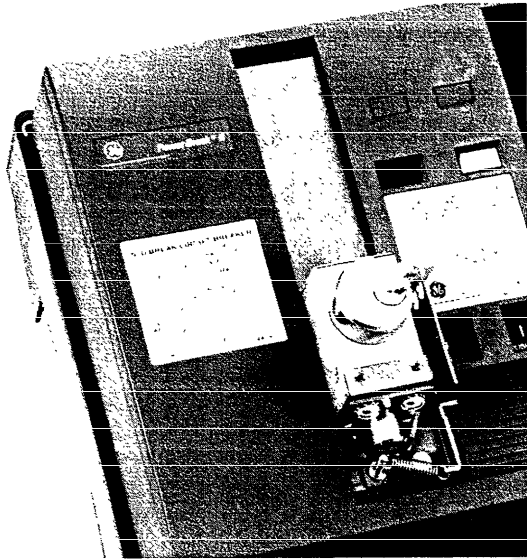

Figure 7. The Key Interlock body attached to the mounting plate.

---

**CAUTION:** Do not attempt to install the breaker cover if the lock bolt is extended, as shown in Figure 7. Turn the key so that the lock bolt retracts and disengages the interlock slide, to prevent the damage described in step 9.

---

**ATTENTION:** Il ne faut pas essayer d'installer le couvercle du disjoncteur si le pêne est tendu, tel que montré à la Figure 7. Tourner la clé de manière à ce que le pêne se rétracte et désengage la coulisse de l'enclenchement afin de prévenir le dommage décrit à l'étape 9.

---

6. For a single key lock, skip to Step 7. For two, three, or four key locks, remove one, two, or three knockouts, respectively. Place the cover face up on a level work surface. Hold a large screw driver vertically, with the tip at the center of the 1.40-inch diameter knockout, and strike the end of the screw driver to remove the knockout.
7. Mount the Key Interlock cover with two #8-32 screws with integral lock washers.
8. Pull the charging handle out once and ratchet it to take the heavy closing-spring force off the handle. Hold the handle out nearly perpendicular to the breaker, then fit it through the handle slot in the breaker cover.
9. **Ensure that the Key Interlock slide does not project across the  $\frac{5}{32} \times 1\frac{2}{32}$ " slot in the cover, or it will interfere with the nylon-coated padlock hasp as the cover is installed, damaging the Key Interlock slide. If necessary, turn the key to retract the lock bolt and slide.**
10. To prevent damage to the breaker cover, check the following:
  - The aluminum accessory sleeve is centered in its window.
  - The Trip Unit flange projects through its window.
  - The gray-painted wire channel is completely inside the cover.
  - The cover is inboard of the trim flanges of both terminal blocks.
11. Slide the cover completely down on the breaker. Install the four cover screws and torque them to 15 in-lb.
12. Attach the split ring through the lower  $\frac{5}{32}$ "-diameter hole in the nylon-coated hasp, as shown in Figure 2. (Omit this step if a Door Interlock, Cat. No. SPDIL, is installed.)

These instructions do not cover all details or variations in equipment nor do they provide for every possible contingency that may be met in connection with installation, operation, or maintenance. Should further information be desired or should particular problems arise that are not covered sufficiently for the purchaser's purposes, the matter should be referred to the GE Company.



**GE Electrical Distribution & Control**

General Electric Company  
41 Woodford Ave., Plainville, CT 06062

Courtesy of [NationalSwitchgear.com](http://NationalSwitchgear.com)

© 1995 General Electric Company