

POWER-ZONE® III Series 2 Low Voltage Metal-Enclosed Drawout Switchgear

Class 6035



CONTENTS

Description	Page
Product Description	1
Application and General Information	2
Technical Overview	14
Dimensions	28
Suggested Specifications	33



SQUARE D
GROUPE SCHNEIDER



General

POWER-ZONE® III Series 2, low voltage metal-enclosed drawout switchgear is premium distribution equipment designed to offer the user many operational security features: minimum down-time, system selectivity, ease of maintenance, and large functional capacity.

The Types DSII (not fusible) and DSLII (fused) low voltage power circuit breakers are the primary components of POWER-ZONE III switchgear. These circuit breakers employ a solid state tripping device offering the latest in circuit protection.

Functional and operational advantages are:

Operational Security Features – Compartmentalized and barriered construction per ANSI C37.20.1.

Dual steel-front barriers: one as the full cell door covering the circuit breaker manual operation controls and one as the front of the circuit breaker element covering the circuit breaker mechanism.

Minimum Down-Time – Drawout construction allows quick and simple replacement of breaker elements. If an emergency occurs, breakers may be removed from low-priority circuits and re-installed to serve high-priority circuits.

Ease of Maintenance – Circuit breakers are simple to inspect, adjust, and replace. They can be withdrawn from their compartments for convenient maintenance or inspection.

Functional Capacity – Large frame sizes and high withstand rating make the DSII and DSLII low voltage circuit breakers ideal for application on today's high capacity distribution systems.

System Selectivity – The solid state trip devices provided on each DSII and DSLII low voltage power breaker are field adjustable, enabling the user to attain optimum selectivity and coordination.

UL® Listing – POWER-ZONE III Series 2 switchgear can be designed and engineered to comply with UL requirements. As an option, DSII and DSLII power circuit breakers are available with a UL listing. Where UL coverage exists for all component material, parts and devices in a switchgear section, a UL label can be affixed.

For Additional Information – POWER-ZONE III Series 2 switchgear is described in general but brief terms here. More detailed and comprehensive data is also available from your local Square D sales office.



Application and General Information

Ratings:

Main Bus – 5000 A maximum
120/208 to 600 Vac, 1Ø3W, or 3Ø4W.

Available Breakers:

DSII, DSLII-308, DSII-508, DSII-608
DSII, DSLII-516, DSII-616
DSII-620
DSII, DSLII-632
DSII, DSLII-840
DSII-850 (Forced air cooled)

800 A Frame
1600 A Frame
2000 A Frame
3200 A Frame
4000 A Frame
5000 A Frame

Applicable Standards:

Circuit Breakers:

NEMA SG3
ANSI C37.13
ANSI C37.16
UL 1066 (Optional)

Structures:

NEMA SG5
ANSI C37.20.1
ANSI C37.51
UL 1558 (Optional)

Features:

- Totally enclosed, dead front, free standing
- Front and rear alignment
- Covers installed with single tool, slotted hex-head screws
- Removable top plate, rear panel, and side panel
- Corrosion-resistant finish
- Single or multiple mains
 - Individually mounted drawout circuit breakers
 - ANSI-rated low voltage power circuit breaker
 - Front accessible, rear connected
 - 100% rated, two-step stored energy circuit breakers
 - 800–5000 A frame
- Feeders
 - Individually mounted drawout circuit breakers
 - ANSI-rated low voltage power circuit breaker
 - Front accessible, rear connected
 - 100% rated, two-step stored energy circuit breakers
 - 800–4000 A frame
- Structures are compartmentalized and barriered per ANSI C37.20.1
- Provision for future extension
- Increased mounting space within main and feeder sections
- Bolted copper bus provided as standard up to 5000 A maximum
- Dual steel-front barriers – the compartment door and the circuit breaker front panel
- Ground bus with lugs
- Shipment as separate switchgear section or up to a maximum of four sections
- Removable lifting straps
- Interrupting rating – 30 kA to 85 kA at 480 Vac (200 kA, when fused)



Indoor Enclosures

Compartmentalized construction:

POWER-ZONE III Series 2 low voltage drawout switchgear offers high reliability through compartmentalized construction.

The three compartments are:

- Circuit breaker or instrument compartment.
- Bus compartment.
- Cable compartment.

Isolation between the bus and cable compartments and/or between adjacent bays is available through optional vertical barriers.

NOTE: If incoming conductors are considered to be "Service Conductors," then barriers as outlined in National Electrical Code® (NEC), Article 384-3 must be specified.

The optional neutral bus is located on the innermost portion of the cable compartment, thereby allowing easy access to line and load connectors.

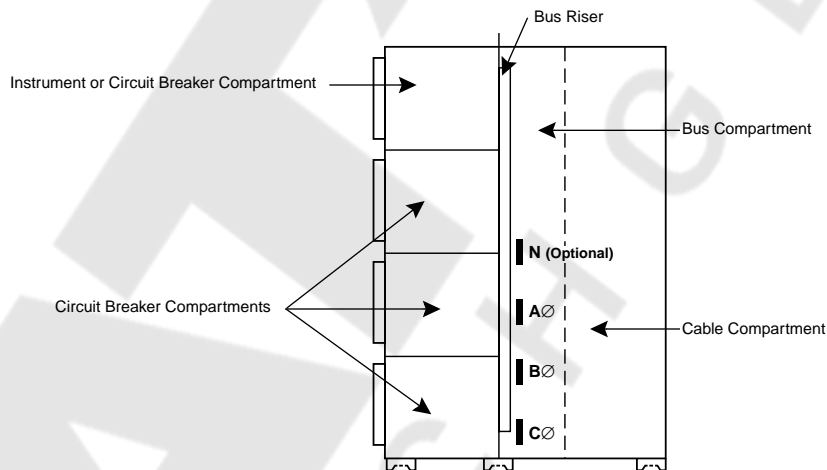

6035-98140

Figure 1: Side View Illustration of Typical Switchgear

Outdoor Enclosures

POWER-ZONE III switchgear is available in a walk-in POWER ZONE® center enclosure for outdoor installation. A non-walk-in enclosure is also available. Both enclosures are NEMA Type 3R as standard.

Non-walk-in enclosures are equipped with:

- Strip heaters in breaker cells and bus compartment
- Front and rear lockable equipment doors with three point latching and filtered openings for ventilation
- Removable gasketed steel cover plates over conduit entrance
- One-piece construction for ease of installation
- Options Available:
 - Mobile floor crane to handle breaker
 - Top entry/exit for incoming and outgoing cables
 - Capability for future expansion
 - Interior and exterior lighting and convenience outlets





6052-88200A

Figure 2: POWER ZONE™ Center – Walk-In Enclosure

The POWER ZONE center-walk-in enclosure is equipped with the following standard features:

- Front aisle with steel entrance door equipped with panic hardware
- Lockable rear equipment doors hinged with 3-point latching and filtered openings for air intake
- Interior fluorescent lighting
- Three-way light switch and convenience outlets located near the entrance door
- Strip heaters in breaker cells and bus compartment
- Overhead breaker lifting device (Traveling Lifter Assembly)
- Removable gasketed steel cover plates over conduit entrance
- One-piece construction for ease of installation
- Options available:
 - Extended aisle for additional work space
 - Exhaust fan ventilation/Inside temperature control
 - Exterior lighting
 - Inside emergency lighting
 - Wall-mounted ac distribution panel
 - Top entry/exit for incoming and outgoing cables
 - Capability for future expansion
 - Modified NEMA Types:
 - NEMA Type 4 and NEMA Type 4X
 - NEMA Type 7 and NEMA Type 9 for use in hazardous areas



POWER-ZONE III Series 2 switchgear uses the Type DSII low-voltage power circuit breaker. This circuit breaker is available in six basic frame sizes that are tabulated along with their respective interrupting capacities on page 14. **The breaker overcurrent protection consists of a solid-state, micro-processor-based trip device that requires no external power source.** The complete tripping system has three basic components: the molded sensors, the trip device (with rating plug), and the trip actuator. The microprocessor-based trip unit uses RMS current level sensing.

Each pole of the circuit breaker is equipped with a molded sensor located on the bottom rear main disconnect contacts. These sensors produce an output proportional to the load current. The output is fed into the trip device, which has the intelligence and energy to operate the trip actuator when required. The trip actuator receives the tripping pulse (from the microprocessor-based trip unit) and mechanically trips the circuit breaker.

Type DSII circuit breakers are equipped with the controls (see Figure 4 on page 6). All circuit breakers are fully stored energy devices with a two-step operating mechanism.

A spring charging handle charges the mechanism and the circuit breaker contacts are closed by pushing the "Push To Close" button, which is located on the face of the circuit breaker. Electrically operated circuit breakers have a motor to charge the stored energy mechanism, electric close feature, and electric open feature.

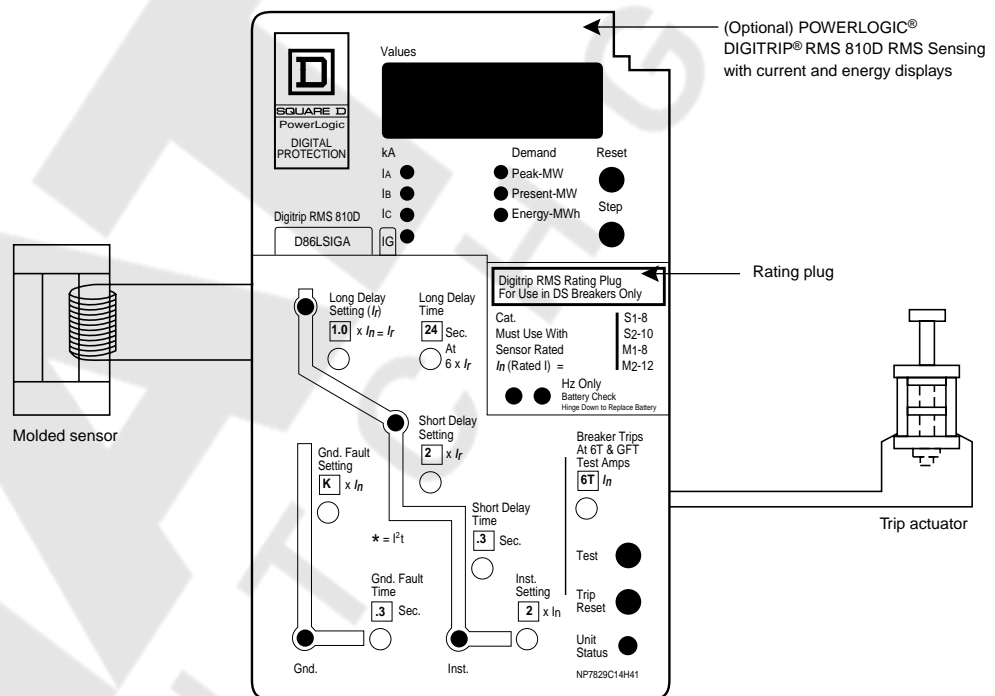

6035-98142

Figure 3: Tripping System



Application and General Information

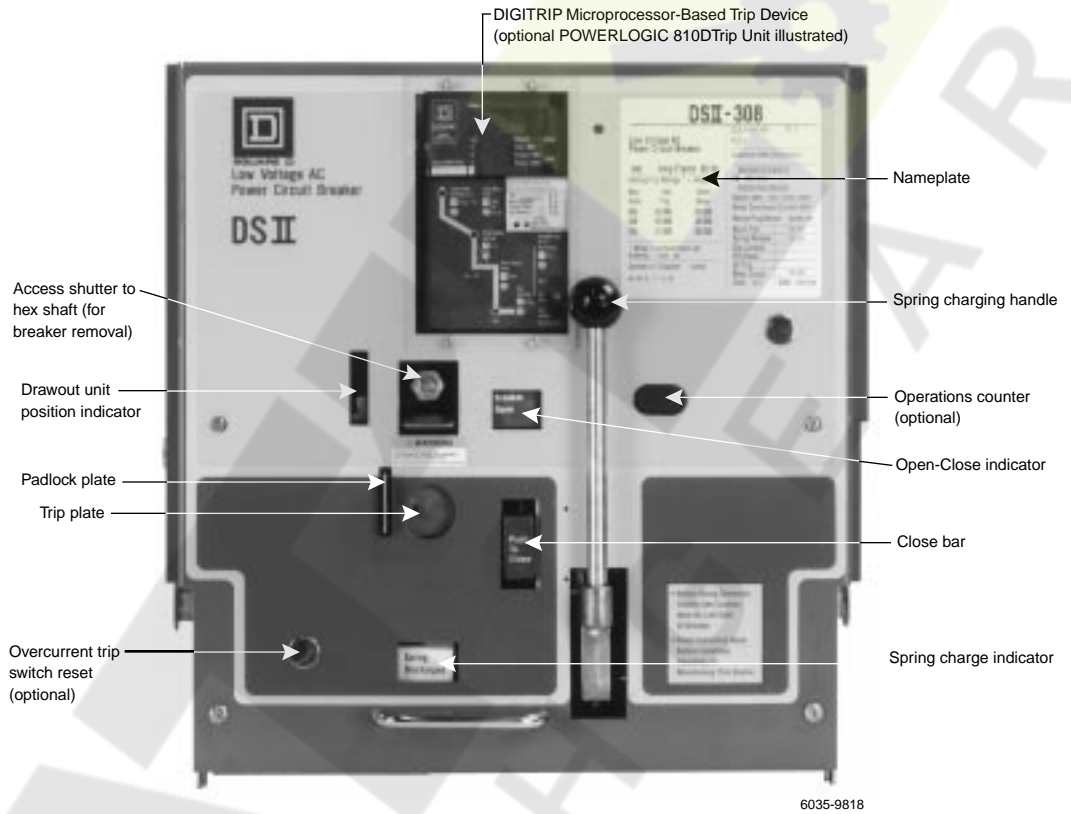

Figure 4: Standard DSII Circuit Breaker

DSII circuit breakers are manufactured to Square D company specifications and are fully warranted and backed by Square D, its sales and technical service personnel.

NOTE: Square D DSII and DSLII circuit breakers are NOT interchangeable with Cutler-Hammer DSII and DSLII circuit breakers.



DIGITRIP® RMS 510 (Standard trip unit)

NOTE: Detailed information on features and operations on the DIGITRIP RMS 510, 610 and POWERLOGIC® 810D trip units can be found in Instruction Bulletin 6035-510 DIGITRIP RMS Trip Units.

Standard trip features include:

- RMS sensing
- Integral trip unit testing
- Unit status indicator
- Adjustable long delay and ampere setting
- Local mode of trip indicators
- Rating plug

Optional features include:

- Adjustable short time delay and pickup
- Adjustable ground fault delay and pickup
- Selectable I²t on short time and ground fault
- Zone selective interlocking (only with other DSII breakers equipped with DIGITRIP trip units.)

DIGITRIP RMS 610 and the POWERLOGIC DIGITRIP RMS 810D are optional.

DIGITRIP RMS 610 (Optional)

Standard trip features include:

- All features of the RMS 510
- Local four-digit alphanumeric display
 - Amperes
 - Mode of trip
 - Service trip messages
- Local hi-load indication
- Remote signal contacts for hi-load and mode of trip (via the auxiliary trip relay-ATR)

POWERLOGIC DIGITRIP RMS 810D (Optional)

Standard trip features include:

- All features of the RMS 510 and RMS 610
- Energy and power monitoring
 - Peak demand^①
 - Present demand^①
 - Energy consumption^①
 - Amperes
 - Energy and demand information
 - Remote breaker operation
 - Service and trip messages
- Direct communications link to the Square D POWERLOGIC Power Monitoring and Control System

^① Energy and demand are calculated in conjunction with a built-in potential transformer module.



Application and General Information



Figure 5: POWER-ZONE III Series 2 LV Drawout Switchgear with POWERLOGIC Circuit Monitors

POWER-ZONE III Series 2 low voltage drawout switchgear is available with the Square D POWERLOGIC circuit monitoring metering, data acquisition, and control system.

Basic circuit information, such as amperes and energy consumption, as well as circuit breaker remote operation, can be accomplished using the POWERLOGIC DIGITRIP 810D trip unit. For more sophisticated metering, power quality monitoring, data acquisition, and control, POWERLOGIC circuit monitors should also be considered.

POWERLOGIC circuit monitors replace a variety of discrete meters, transducers, and other components. POWERLOGIC circuit monitors perform these functions:

- Meters Amperes, Volts
- Frequency
- Watts
- Thermal Demand
- Vars
- Watthour with Demand
- Kilovolt-ampere
- Varhours
- Power Factor
- Waveform capture
- Records data

Industry standard RS-485 data communications allow the POWERLOGIC system to replace multiple transducers, analog wires, and analog-to-digital conversion equipment. Extensive information can be transmitted over a single communications cable to a POWERLOGIC system display, a personal computer, programmable logic controller, or other host system.

In addition to its metering capabilities, the POWERLOGIC system is available with optional status inputs and relay outputs for monitoring discrete contacts and remote control of devices via the data communications channel.

A POWERLOGIC circuit monitor, equipped with a "waveform capture" function, offers a highly accurate class of circuit information, not presently available on the built in trip unit devices. Comprehensive profiles of current and voltage waveforms, suitable for harmonics studies and other power quality analyses, are reported on user-command.

For additional information regarding POWERLOGIC systems consult your local Square D sales office.



Application and General Information

The main disconnecting contacts on the rear of the circuit breaker are spring loaded and self-aligning to ensure positive electrical contact when the circuit breaker is in the connected position. These contacts are designed so the pressure at the point of contact on the stationary stud becomes greater under short circuit conditions.

The secondary disconnecting contacts are also located on the rear of the circuit breaker element and are used for connecting the accessories to the control power source or other control circuits. These contacts are in the "make" position when the element is in the "Connected" and "Test" positions. See photo below.

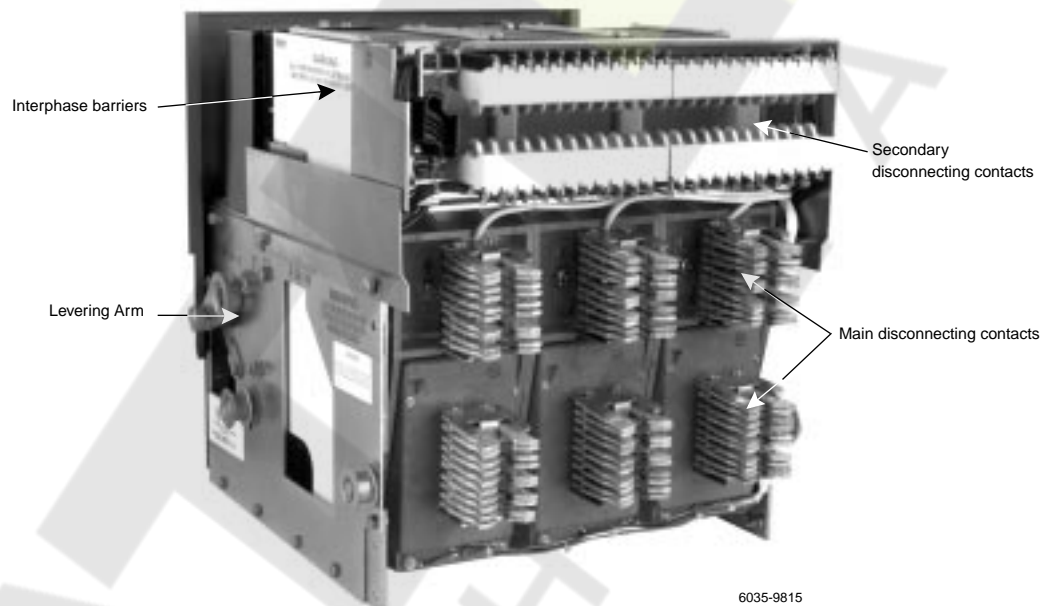

Figure 6: Rear View of DSII Circuit Breaker Element

Circuit breakers of like frame sizes and interrupting ratings are interchangeable as standard.



Application and General Information

POWER-ZONE III Switchgear is also available with fused power circuit breakers. Fused circuit breakers have a short circuit interrupting fusing of 200,000 A symmetrical. The circuit breaker element, including the microprocessor-based tripping system, is identical to that of a non-fusible circuit breaker except for the addition of the fuses and other circuitry necessary for the proper functioning of the fuse protection system.

Current limiting fuses are available on the 800 A, 1600 A, 3200 A, and 4000 A frame power circuit breakers. The current limiting fuses are mounted integrally on the rear of the circuit breaker element for the 800 A and 1600 A frame sizes and are mounted on a separate drawout truck for the 3200 A and 4000 A frame sizes. When fuses are mounted on a separate fuse truck, the drawout mechanisms are mechanically key interlocked with the circuit breaker element. The Square D 3200 A and 4000 A fused circuit breaker design permits mounting both the fuse drawout truck and circuit breaker element in the same vertical section (see Figure 7.)

All versions of the fused circuit breaker are equipped with blown fuse indication and anti-single phasing as standard.

Fused circuit breakers of like frame sizes are interchangeable as standard.



Figure 7: Two Bay POWER-ZONE III Series 2 Switchgear with DSLII 840 Shown with Optional Lifter Assembly



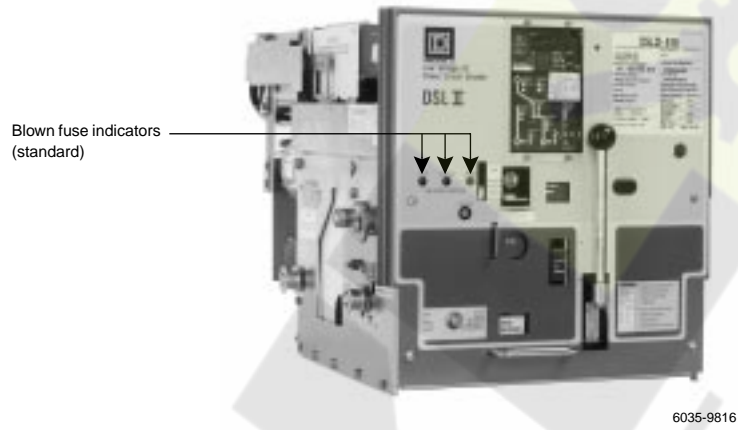

Figure 8: Front View of DSLII Circuit Breaker

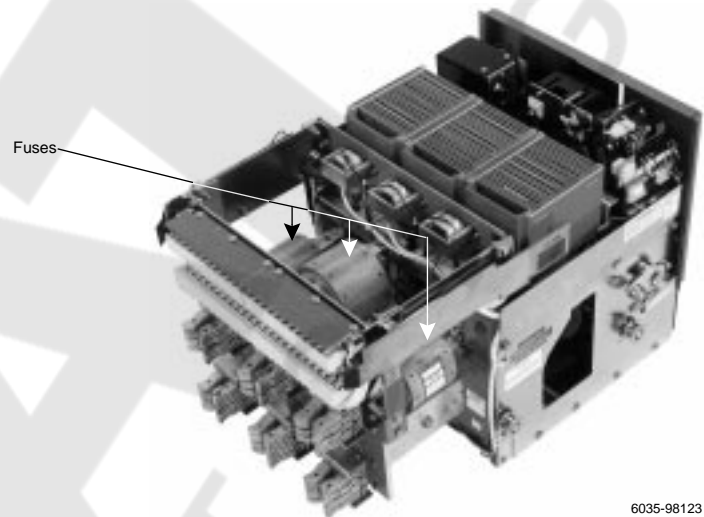

Figure 9: Rear View of DSLII Circuit Breaker Equipped with Integral Current Limiting Fuses

Application and General Information

Test and Maintenance Option

All Type DSII and DSLII power circuit breakers equipped with microprocessor-based trip devices have a built-in test feature, as well as plug-in type test facilities that enable the user to test all tripping functions.

The DSII circuit breaker test cart provides mobility for moving circuit breakers to the test area, a convenient height for visual inspection of circuit breakers, contacts for testing all secondary control functions, means for verification of mechanical operation, and a test equipment shelf for mounting the test kit.



Figure 10: Test Cart



Miscellaneous Circuit Breaker Options and Accessories

- DIGITRIP 610 and POWERLOGIC 810D trip units
- Shunt trip for manually operated circuit breakers
- Auxiliary switch with four 10 A contacts. A maximum of ten 10 A contacts can be supplied per circuit breaker.
- Cell switch with 6 Form "A" and 6 Form "B". Operates when circuit breaker is drawn from connected to test position.
- Undervoltage trip—instantaneous or time delay type. Trips the circuit breaker on 30-60% undervoltage.
- Overcurrent trip switch operates and latches when circuit breaker is automatically tripped on overload or fault conditions.
- Electric lockout for manually operated circuit breakers
- Electric close release for manually operated circuit breakers
- Key interlocks
- Operations counter
- AC capacitor trip
- Integral ground fault sensing
- Insulated switchgear bussing
- UL Label

A rail-mounted traveling type circuit breaker lifting device is optionally available with indoor type switchgear. It is supplied as standard with outdoor walk-in enclosures.



6035-98134a

Figure 11: Circuit Breaker Lifting Device



Technical Overview

Ratings



6035-98135

Interrupting Ratings of Type DSII Circuit Breaker (RMS Symmetrical Amperes)

Trip Current Range	Circuit Breaker Type	With Instantaneous Trip			With Short Delay Trip		
		208-240V	480V	600V	208-240V	480V	600V
50-800	DSII-308	42,000	30,000	30,000	30,000	30,000	30,000
50-800	DSII-508	65,000	50,000	42,000	50,000	50,000	42,000
50-800	DSII-608	65,000	65,000	50,000	65,000	65,000	50,000
50-1600	DSII-516	65,000	50,000	42,000	50,000	50,000	42,000
50-1600	DSII-616	65,000	65,000	50,000	65,000	65,000	50,000
50-2000	DSII-620	65,000	65,000	50,000	65,000	65,000	50,000
800-3200	DSII-632	85,000	65,000	65,000	65,000	65,000	65,000
1000-4000	DSII-840	130,000	85,000	85,000	85,000	85,000	85,000
1600-5000	DSII-850 ^①	130,000	85,000	85,000	85,000	85,000	85,000
50-800	DSLII-308	All Ranges: 200,000					
50-1600	DSLII-516						
800-3200	DSLII-632						
1000-4000	DSLII-840						

Available Sensors

Circuit Breaker Type	Sensor Rating (Amperes)
DSII-308, DSLII-308, DSII-508, DSII-608	200, 300, 400, 600, 800
DSII-516, DSLII-516, DSII-616	200, 300, 400, 600, 800, 1200, 1600
DSII-620	200, 300, 400, 600, 800, 1200, 1600, 2000
DSII-632	2400, 3200
DSII-840	4000
DSII-850 ^①	5000

^① DSII-850 - Forced air cooled.

Available Rating Plugs

Sensor Rating Amperes	Plug Rating in Amperes
200	100, 200
300	200, 250, 300
400	200, 250, 300, 400
600	300, 400, 600
800	400, 600, 800
1200	600, 800, 1000, 1200
1600	800, 1000, 1200, 1600
2000	1000, 1200, 1600, 2000
2400	1600, 2000, 2400
3200	1600, 2000, 2400, 3000, 3200
4000	2000, 2400, 3200, 4000
5000	3200, 4000, 5000

Digitrip RMS Adjustable Trip Settings

Time/Current Characteristic	Pick-Up Setting	Pick-Up Point ^①	Time Band, Seconds
Long Delay	0.5, 0.6, 0.7, 0.8, 0.85, 0.9, 0.95, 1.0	I_n Times Long Delay Setting	2, 4, 7, 10, 12, 15, 20, 24 (at 6 times pick-up value)
Instantaneous	2, 2.5, 3, 4, 5, 6 $M_1=8, M_2=12$	I_n Times Instantaneous Setting	
Short Delay	2, 2.5, 3, 4, 5, 6 $S_1=8, S_2=10$	I_T Times Short Delay Setting	0.1, 0.2, 0.3, 0.4, 0.5 (Flat Response) 0.1*, 0.3*, 0.5 * (I^2t Response)
Ground Fault	A (.25), B (.3), C (.35), D (.4), E (.5), F (.6), H (.75), K (1.0) (1200A Max.)	I_n Times Ground Fault Setting	0.1, 0.2, 0.3, 0.4, 0.5 (Flat Response) 0.1*, 0.3*, 0.5 * (I^2t Response)

^① I_n = Rating Plug Value I_T = Long Delay Pickup Setting X I_n



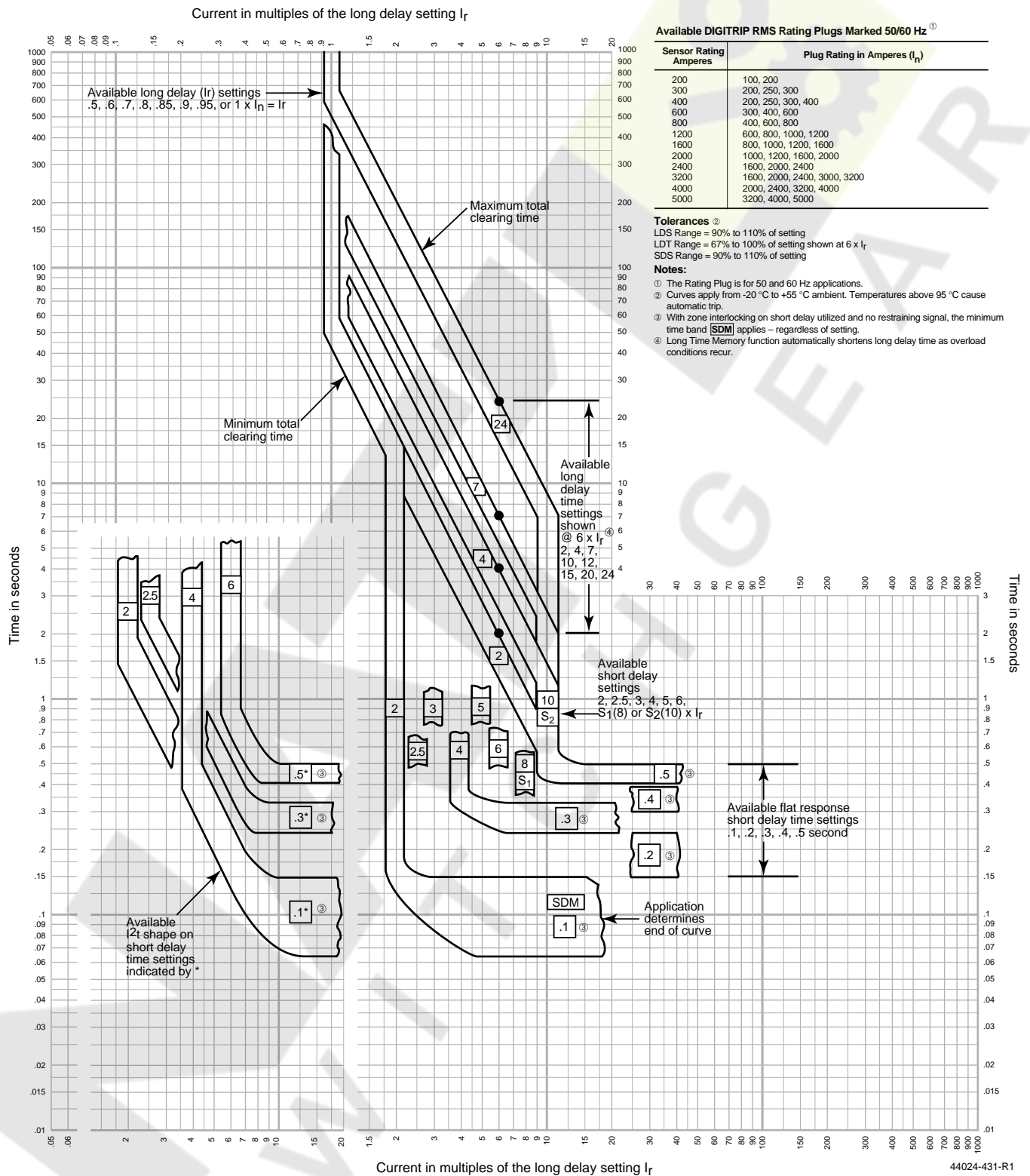

Figure 12: Typical Long Delay and Short Delay Time-Phase Current Characteristic Curve (LS) for Types DSII and DSLII Circuit Breakers with DIGITRIP RMS 510/610/POWERLOGIC 810D



Technical Overview

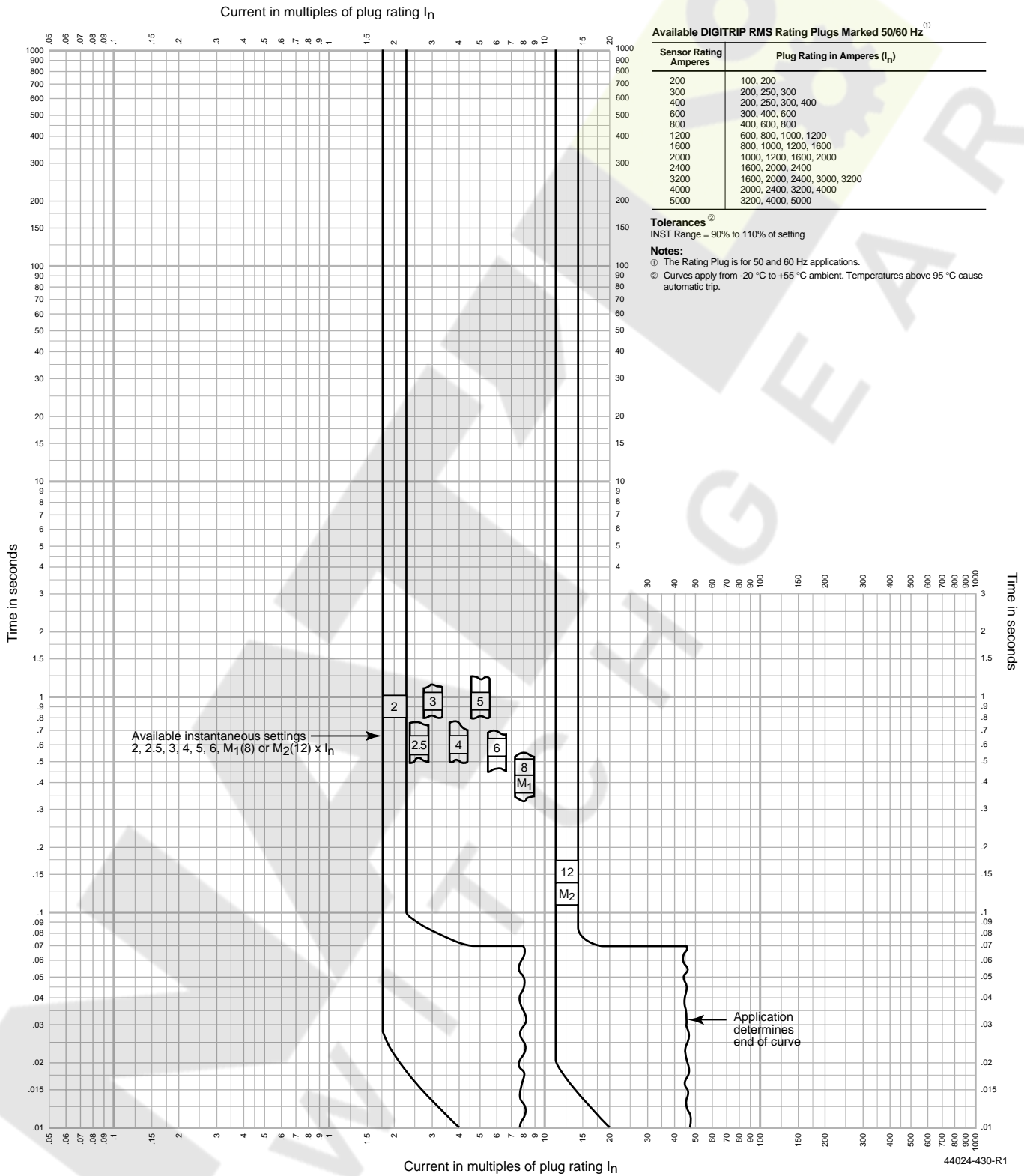
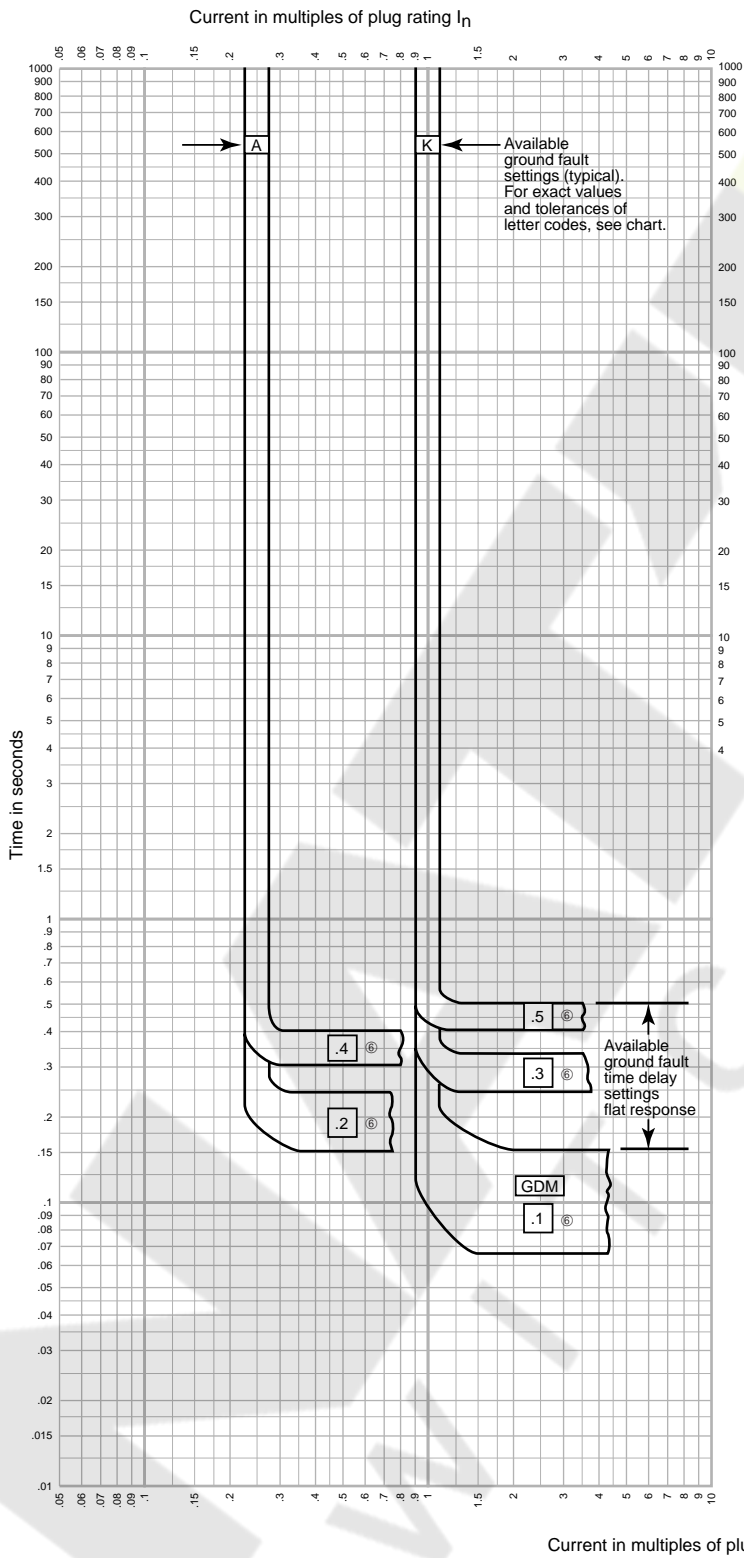

Figure 13: Typical Instantaneous Time-Phase Current Characteristic Curve (I) for Types DSII and DSLII Circuit Breakers with DIGITRIP RMS 510/610/POWERLOGIC 810D





Ground Fault Settings (Amperes) ① ③ ④

Code	A ^②	B ^②	C ^②	D ^②	E	F	H	K
100	25	30	35	40	50	60	75	100
200	50	60	70	80	100	120	150	200
250	63	75	88	100	125	150	188	250
300	75	90	105	120	150	180	225	300
400	100	120	140	160	200	240	300	400
600	150	180	210	240	300	360	450	600
800	200	240	280	320	400	480	600	800
1000	250	300	350	400	500	600	750	1000
1200	300	360	420	480	600	720	900	1200
1600	400	480	560	640	800	960	1200	1200
2000	500	600	700	800	1000	1200	1200	1200
2400	600	720	840	960	1200	1200	1200	1200
3200	800	960	1120	1200	1200	1200	1200	1200
4000	1000	1200	1200	1200	1200	1200	1200	1200
5000	1200	1200	1200	1200	1200	1200	1200	1200

Notes:

- ① Except as noted, tolerances on current levels are ±10% of values shown in chart.
- ② For Testing Purposes Only: When using an external single phase current source to check low level ground fault current settings, it is advisable to use the Auxiliary Power Module (APM). See TEST PROCEDURES in Instruction Leaflet.
- ③ The Rating Plug is for 50 and 60 Hz applications.
- ④ All tabulated values are based on the use of a residual sensing scheme with the same rated current sensor in all phase and neutral conductors.
- ⑤ Curves apply from -20 °C to +55 °C ambient; temperatures above 95 °C cause automatic trip.
- ⑥ With zone interlocking on ground fault utilized and no restraining signal, the minimum time band **GDM** applies – regardless of setting.

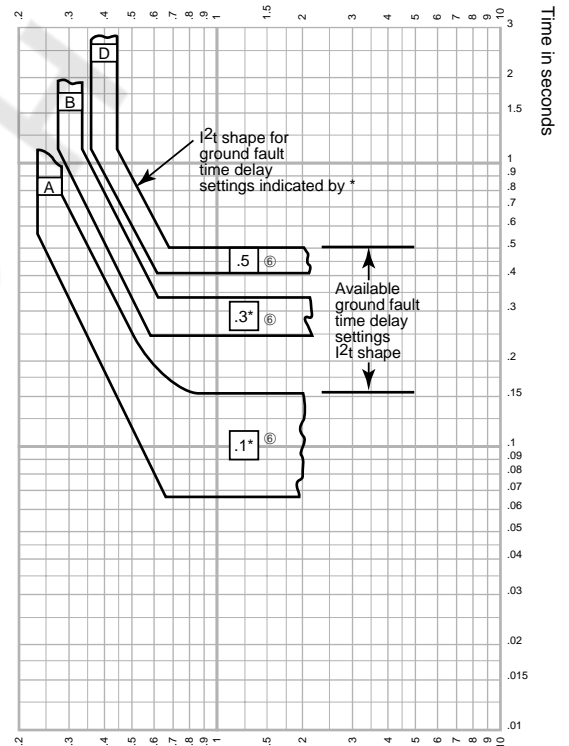

Figure 14: Typical Ground Fault/Protection Time-Phase Current Characteristic Curve (G) for Types DSII and DSLII Circuit Breakers with DIGITRIP RMS 510/610/POWERLOGIC 810D



Technical Overview

DSL circuit breakers are equipped with limiters having characteristics as illustrated in curves A (Figure 15 on page 19) through E (Figure 20 on page 24). Fuse limiters are used where fault currents exceed the interrupting capacity of the circuit breaker alone. The let-through and I^2T characteristics of the limiters are coordinated with the circuit breaker elements to allow safe application on circuits that have available fault currents up to 200,000 RMS symmetrical amperes.

Selection of the proper limiter size depends upon whether the function of the limiter is to protect downstream equipment or to protect the circuit breaker. If downstream equipment protection is the main criterion, the smallest available limiter should be selected. Due to coordination problems, selection of certain small limiters may cause nuisance blowing on overloads or low-level short circuits. For protection of the circuit breaker only, the largest available limiter should be selected.

The table below lists available limiter ratings for DSLII-308 and DSLII-516 circuit breakers.

Circuit Breaker Type	Sensor Rating Amperes	Limiter Rating, Amperes		
		Minimum ^①	Recommended ^②	Maximum ^③
DSLII-308	50 or 100	150	1200	2000
DSLII-308	150	200	1200	2000
DSLII-308	200	250	1200	2000
DSLII-308	300	400	1200	2000
DSLII-308	400	600	1200	2000
DSLII-308	600	800	1200	2000
DSLII-308	800	1200	1200	2000
DSLII-516	600	800	2000	3000
DSLII-516	800	1000	2000	3000
DSLII-516	1200	2000	2500	3000
DSLII-516	1600	3000	3000	3000

^① For use only when protection of downstream equipment is required. Not completely coordinated with circuit breaker to avoid nuisance blowing.

^② Lowest rating that can be coordinated with circuit breaker to minimize nuisance blowing.

^③ Highest available ratings, for protection of circuit breaker only.

Limiters are mounted in separate trucks for the DSLII-632 and DSLII-840 circuit breakers. Three sizes, 2500, 3000, and 4000 A capacity, are available for DSLII-632. Four sizes, 2500, 3000, 4000, and 5000 A capacity, are available for DSLII-840.



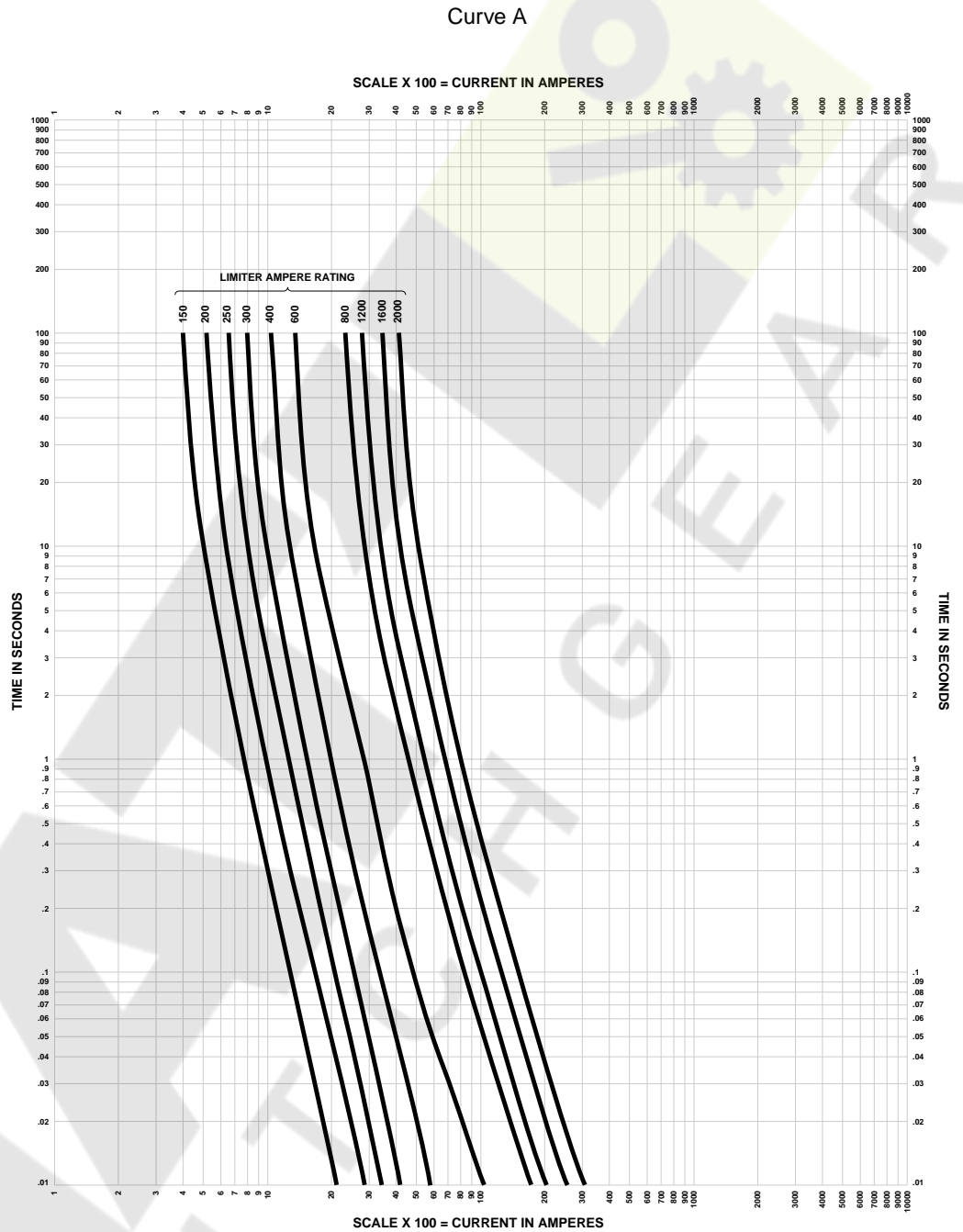

44025-793-R1

Figure 15: Type DSLII-308 Limiters: Average Melting Time and Current Characteristics



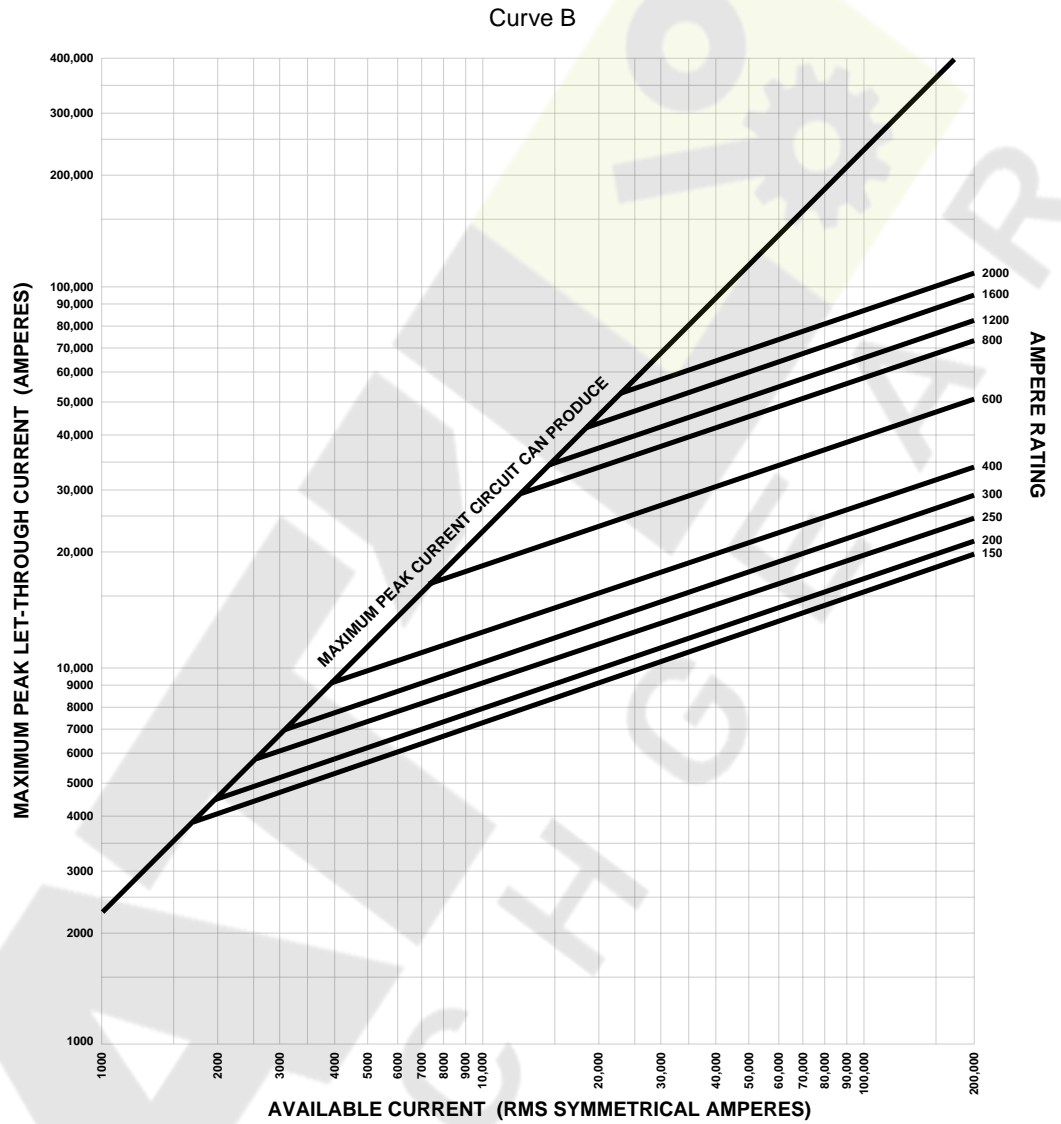

44025-796-R1

Figure 16: Type DSLII-308 Limiters: Let-through Characteristics



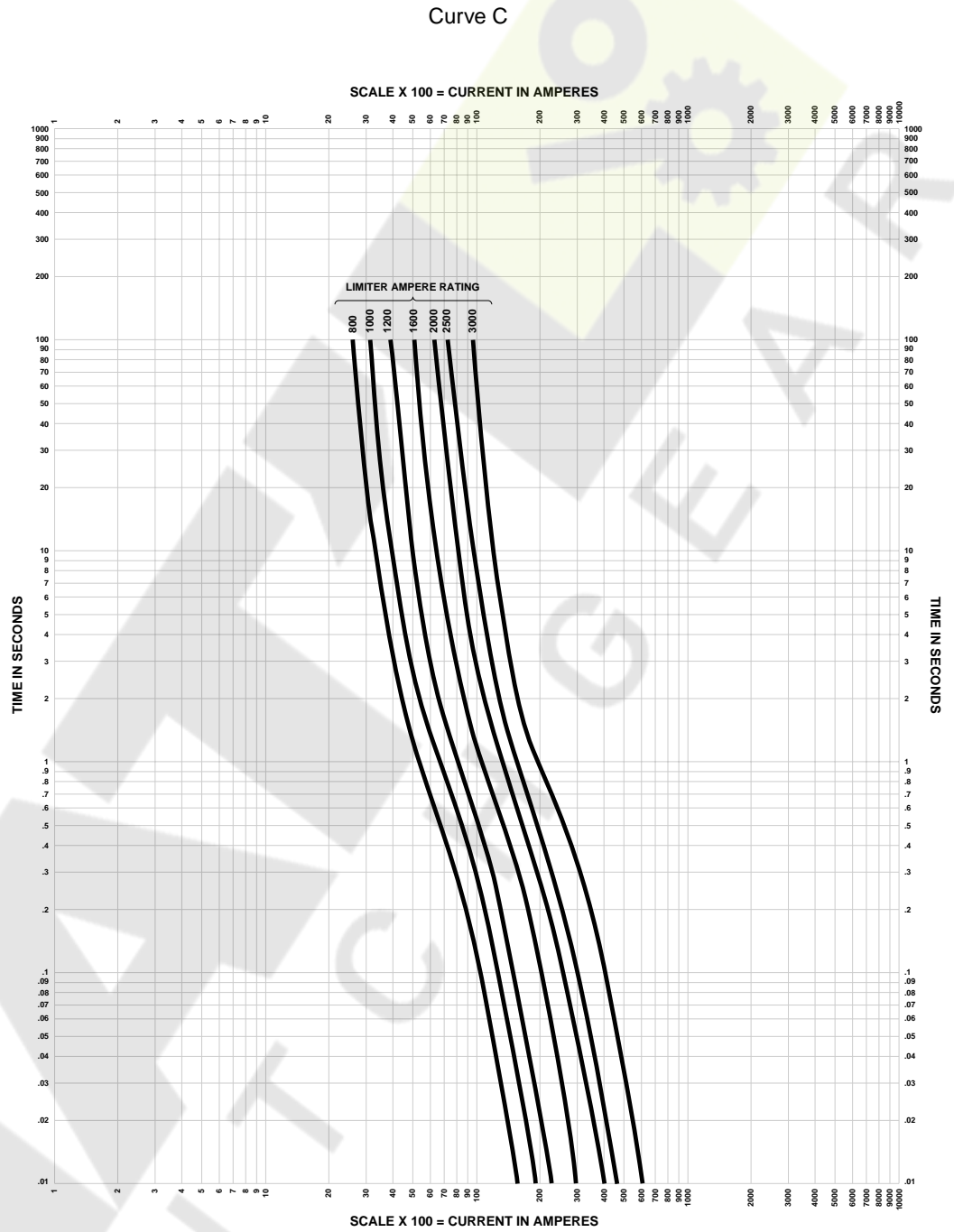

Figure 17: Type DSLII-516 Limiters: Average Melting Time and Current Characteristics



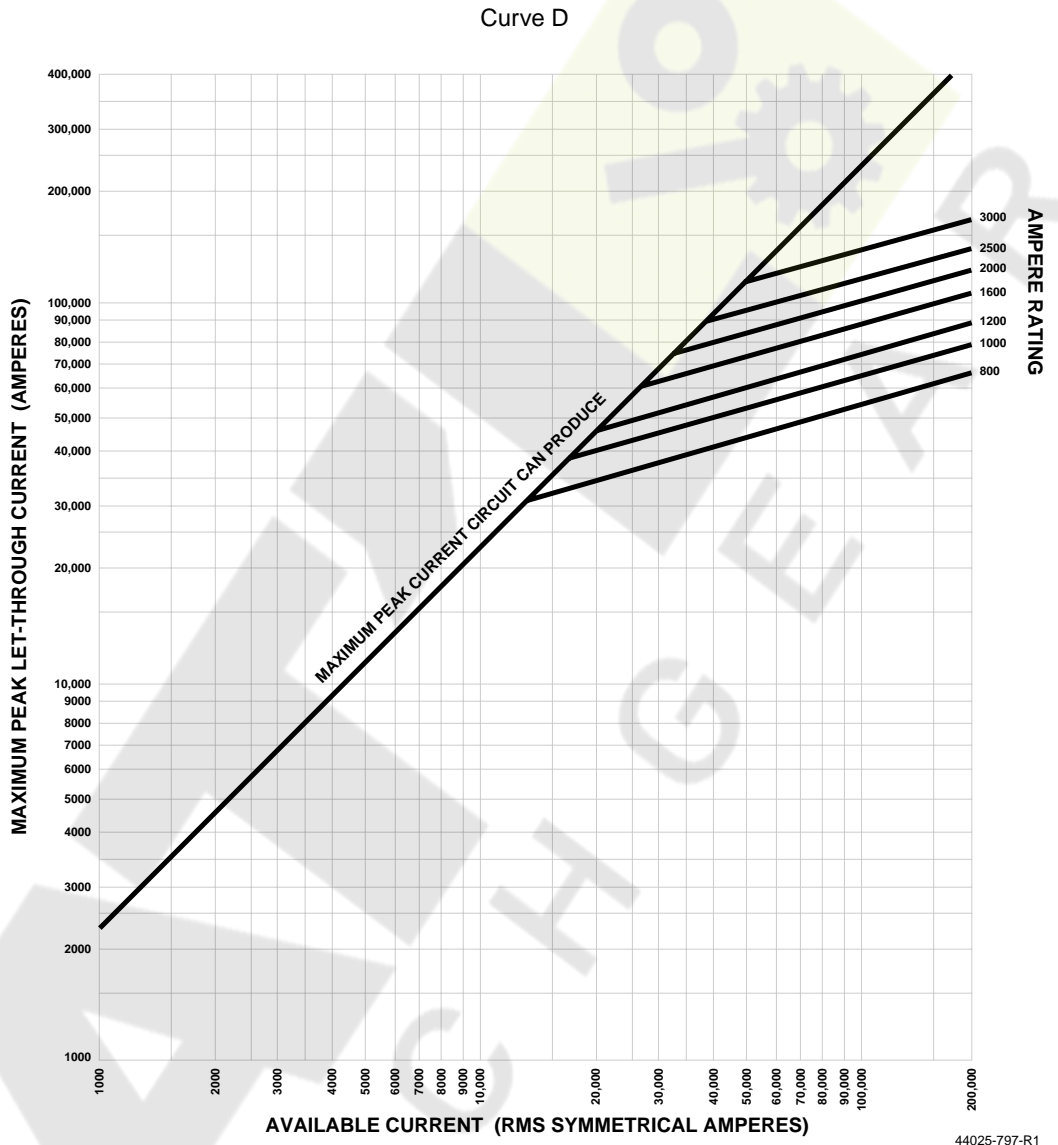

Figure 18: Type DSLII-516 Limiters: Let-through Characteristics



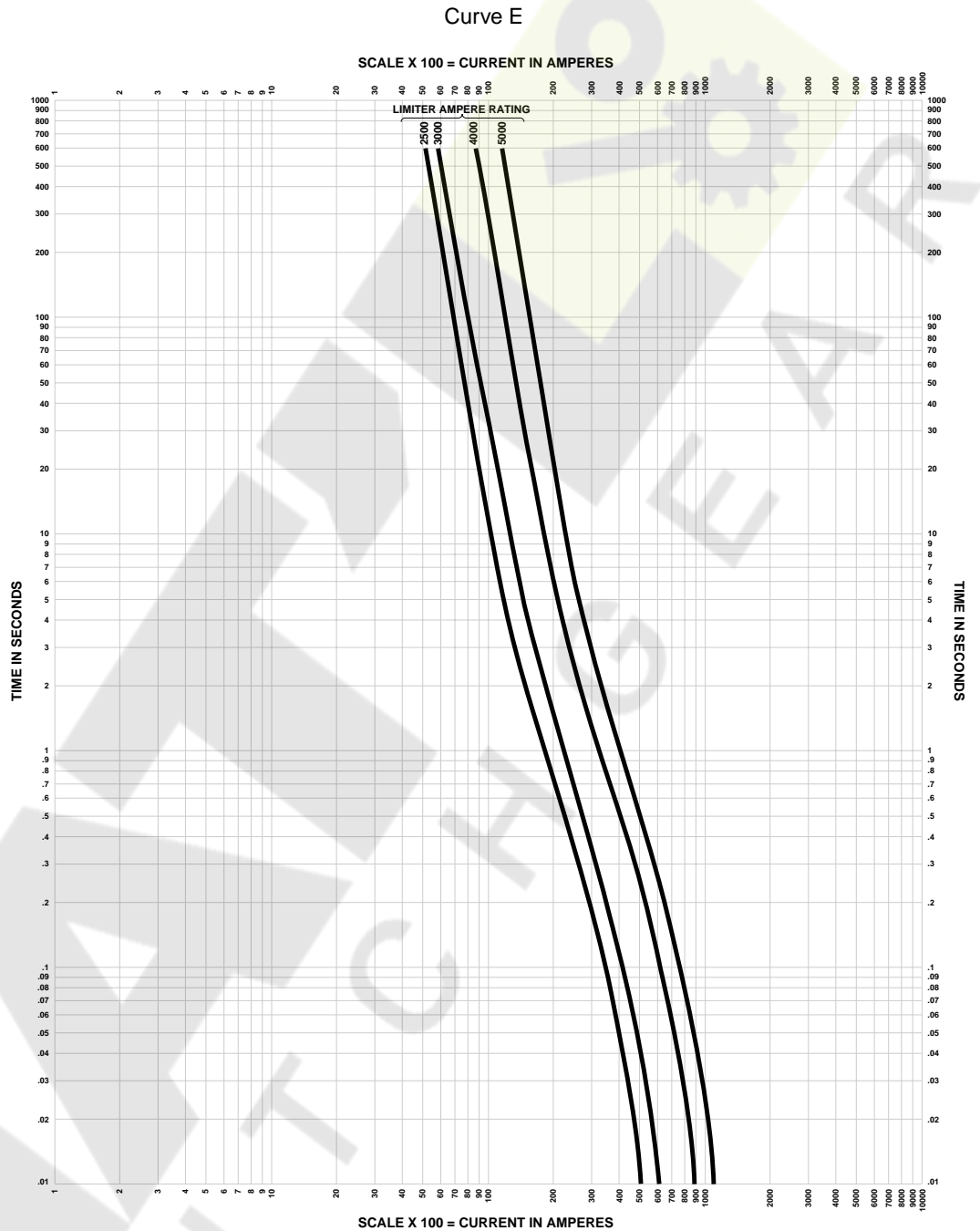

Figure 19: Types DSLII-632 and DSLII-840 Limiters: Average Melting Time and Current Characteristics



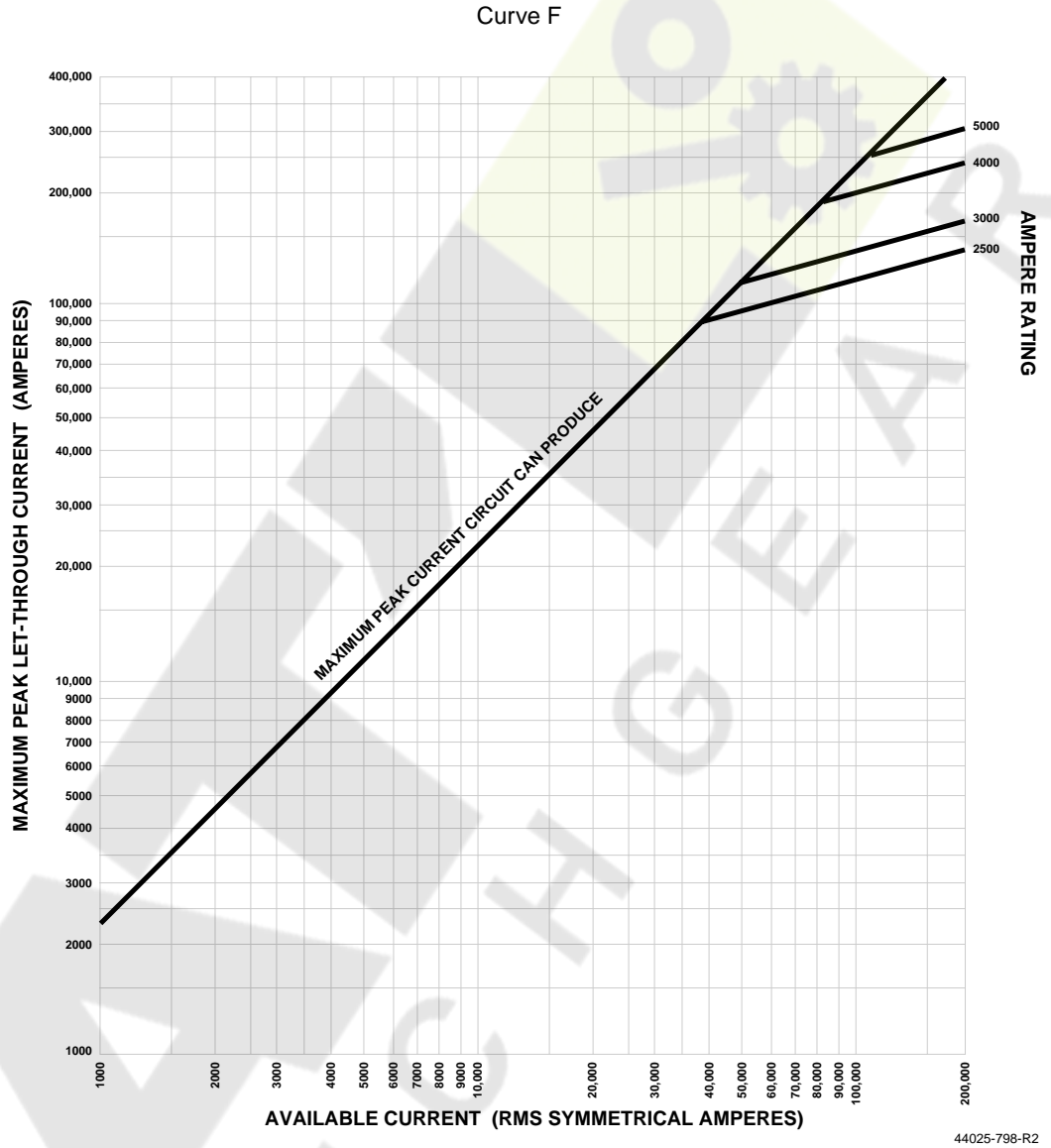

Figure 20: Types DSLII-632 and DSLII-840 Limiters: Let-through Characteristics



**Application of Type DSII Air Circuit Breakers
With Standard Three-Phase Transformers—Fluid Filled and Ventilated Dry Types**

Transformer Base (100%) Rating			Secondary Short-Circuit Currents RMS Symmetrical Amperes			Minimum Size Circuit Breakers for Selective Trip Systems		
kVA and Percent Impedance	Amperes ①	Max. Short Circuit kVA Available from Primary System	Through Transformer Only	Motor Contribution	Combined	Main Circuit Breaker Short Delay Trip	Feeder Circuit Breaker Short Delay Trip	Feeder Circuit Breaker Instantaneous Trip
208 V Three-Phase – 50% Motor Load								
300 5.0%	833	50000	14900	1700	16600	DSII-516	DSII-308	DSII-308
		100000	15700		17400			
		150000	16000		17700			
		250000	16300		18000			
		500000	16500		18200			
Unlimited	16700	18400						
500 5.0%	1389	50000	23100	2800	25900	DSII-516 ②	DSII-308	DSII-308
		100000	25200		28000			
		150000	26000		28800			
		250000	26700		29500			
		500000	27200		30000			
Unlimited	27800	30600						
750 5.75%	2083	50000	28700	4200	32900	DSII-632	DSII-508	DSII-308
		100000	32000		36200			
		150000	33300		37500			
		250000	34400		38600			
		500000	35200		39400			
Unlimited	36200	40400						
1000 5.75%	2778	50000	35900	5600	41500	DSII-632 ②	DSII-508	DSII-308
		100000	41200		46800			
		150000	43300		48900			
		250000	45200		50800			
		500000	46700		52300			
Unlimited	48300	53900						
240 V Three-Phase – 100% Motor Load								
300 5.0%	722	50000	12900	2900	15800	DSII-308 ②	DSII-308	DSII-308
		100000	13600		16500			
		150000	13900		16800			
		250000	14100		17000			
		500000	14300		17200			
Unlimited	14400	17300						
500 5.0%	1203	50000	20000	4800	24800	DSII-516 ②	DSII-308	DSII-308
		100000	21900		26700			
		150000	22500		27300			
		250000	23100		27900			
		500000	23600		28400			
Unlimited	24100	28900						
750 5.75%	1804	50000	24800	7200	32100	DSII-620 ②	DSII-508	DSII-308
		100000	27800		35000			
		150000	28900		36100			
		250000	29800		37000			
		500000	30600		37800			
Unlimited	31400	38600						
1000 5.75%	2406	50000	31000	9600	40600	DSII-632 ②	DSII-508	DSII-308
		100000	35600		45200			
		150000	37500		47100			
		250000	39100		48700			
		500000	40400		50000			
Unlimited	41800	51400						

① At transformer self-cooled rating.
 ② Next larger frame size main circuit breaker may be required for 55/65 °C rise and/or forced air-cooled (FA) transformer. Check Transformer Secondary Ampere Rating.



Technical Overview

Application of Type DSII Air Circuit Breakers With Standard Three-Phase Transformers Fluid Filled and Ventilated Dry Types

Transformer Base (100%) Rating			Secondary Short-Circuit Currents RMS Symmetrical Amperes			Minimum Size Circuit Breakers for Selective Trip Systems		
kVA and Percent Impedance	Amperes ①	Max. Short Circuit kVA Available from Primary System	Through Transformer Only	Motor Contribution	Combined	Main Circuit Breaker Short Delay Trip	Feeder Circuit Breaker Short Delay Trip	Feeder Circuit Breaker Instantaneous Trip
480 V Three-Phase – 100% Motor Load								
500 5.0%	601	50000	10000	2400	12400	DSII-308 ②	DSII-308	DSII-308
		100000	10900		13300			
		150000	11300		13700			
		250000	11600		14000			
		500000	11800		14200			
Unlimited	12000	14400						
750 5.75%	902	50000	12400	3600	16000	DSII-516	DSII-308	DSII-308
		100000	13900		17500			
		150000	14400		18000			
		250000	14900		18500			
		500000	15300		18900			
Unlimited	15700	19300						
1000 5.75%	1203	50000	15500	4800	20300	DSII-516 ②	DSII-308	DSII-308
		100000	17800		22600			
		150000	18700		23500			
		250000	19600		24400			
		500000	30200		25000			
Unlimited	20900	25700						
1500 5.75%	1804	50000	20600	7200	27800	DSII-620 ②	DSII-308	DSII-308
		100000	24900		32100			
		150000	26700		33900			
		250000	28400		35600			
		500000	29800		37000			
Unlimited	31400	38600						
2000 5.75%	2406	50000	24700	9600	34300	DSII-632 ②	DSII-508	DSII-508
		100000	31000		40600			
		150000	34000		43600			
		250000	36700		46300			
		500000	39100		48700			
Unlimited	41800	51400						
2500 5.75%	3008	50000	28000	12000	40000	DSII-632 ②	DSII-508	DSII-508
		100000	36500		48500			
		150000	40500		52500			
		250000	44600		56600			
		500000	48100		60100			
Unlimited	52300	64300						
3000 5.75%	3609	50000	30700	14000	44700	DSII 840 ②	DSII-508	DSII-508
		100000	41200		55200			
		150000	46600		60600			
		250000	51900		65900			
		500000	56800		70800			
Unlimited	62800	76800						
3750 5.75%	4511	50000	34000	18000	52000	DSII-850	DSII-608	DSII-608
		100000	47500		65500			
		150000	54700		72700			
		250000	62200		80200			
		500000	69400		87400			
Unlimited	78500	96500						

① At transformer self-cooled rating.

② Next larger frame size main circuit breaker may be required for 55/65 °C rise and/or forced air-cooled (FA) transformer. Check Transformer Secondary Ampere Rating.



**Application of Type DSII Air Circuit Breakers
With Standard Three-Phase Transformers Fluid filled and Ventilated Dry Types**

Transformer Base (100%) Rating			Secondary Short-Circuit Currents RMS Symmetrical Amperes			Minimum Size Circuit Breakers for Selective Trip Systems		
kVA and Percent Impedance	Amperes ①	Max. Short Circuit kVA Available from Primary System	Through Transformer Only	Motor Contribution	Combined	Main Circuit Breaker Short Delay Trip	Feeder Circuit Breaker Short Delay Trip	Feeder Circuit Breaker Instantaneous Trip
600 V Three-Phase – 100% Motor Load								
500 5.0%	481	50000	8000	1900	9900	DSII-308	DSII-308	DSII-308
		100000	8700		10600			
		150000	9000		10900			
		250000	9300		11200			
		500000	9400		11300			
Unlimited	9600	11500						
750 5.75%	722	50000	10000	2900	12900	DSLII-308 ②	DSII-308	DSII-308
		100000	11100		14000			
		150000	11600		14500			
		250000	11900		14800			
		500000	12200		15100			
Unlimited	12600	15500						
1000 5.75%	962	50000	12400	3900	16300	DSII-516	DSII-308	DSII-308
		100000	14300		18200			
		150000	15000		18900			
		250000	15600		19500			
		500000	16200		30100			
Unlimited	16700	20600						
1500 5.75%	1443	50000	16500	5800	22300	DSLII-516 ②	DSII-308	DSII-308
		100000	20000		25800			
		150000	21400		27200			
		250000	22700		28500			
		500000	23900		29700			
Unlimited	25100	30900						
2000 5.75%	1924	50000	19700	7700	27400	DSII-602 ②	DSII-308	DSII-308
		100000	24800		32500			
		150000	27200		34900			
		250000	29400		37100			
		500000	31300		39000			
Unlimited	33500	41200						
2500 5.75%	2406	50000	22400	9600	32000	DSII-632 ②	DSII-508	DSII-508
		100000	29200		38800			
		150000	32400		42000			
		250000	35600		45200			
		500000	38500		48100			
Unlimited	41800	51400						
3000 5.75%	2886	50000	24600	11500	36100	DSII-632 ②	DSII-508	DSII-508
		100000	33000		44500			
		150000	37300		48800			
		250000	41500		53000			
		500000	45500		57000			
Unlimited	50200	61700						
3750 5.75%	3608	50000	27200	14400	41600	DSII-840 ②	DSII-508	DSII-508
		100000	38000		52400			
		150000	43700		58100			
		250000	49800		64200			
		500000	55500		69900			
Unlimited	62800	77200						

① At transformer self-cooled rating.
 ② Next larger frame size main circuit breaker may be required for 55/65 °C rise and/or forced air-cooled (FA) transformer. Check Transformer Secondary Ampere Rating.



Dimensions

Layout

Approximate Dimensions—Not for Construction

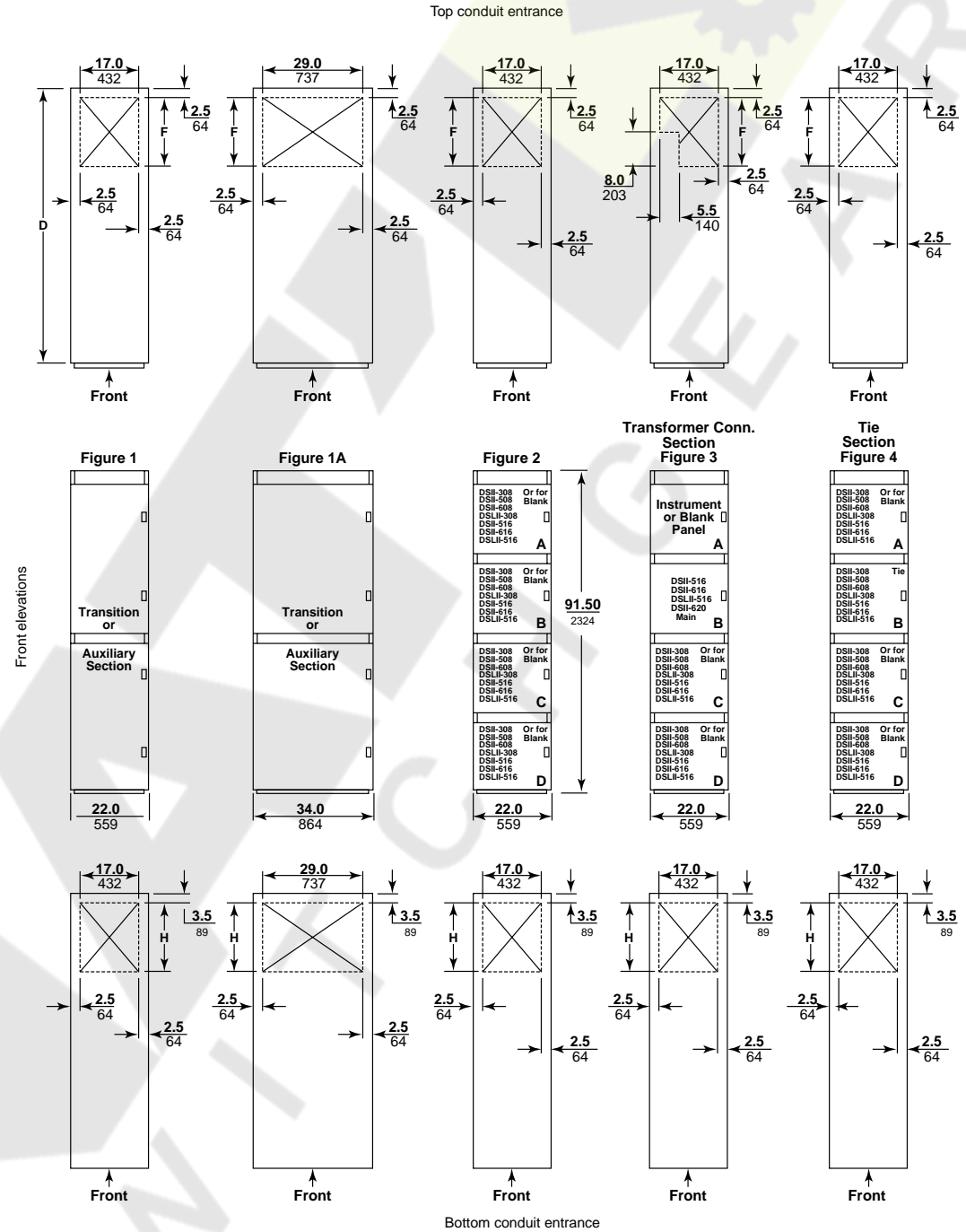

6035-10



Layout

Approximate Dimensions—Not for Construction

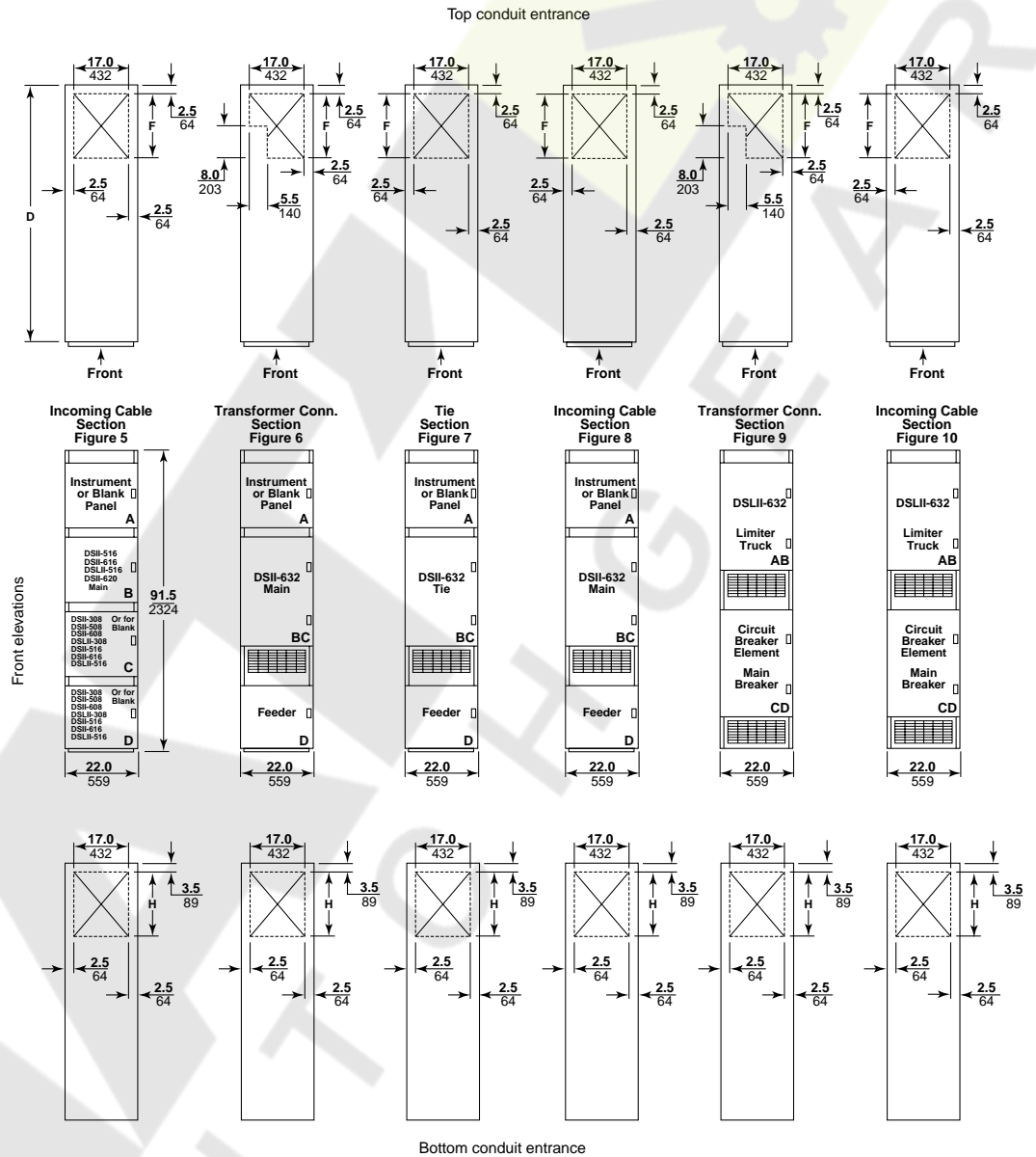

6035-11



Dimensions

Layout

Approximate Dimensions—Not for Construction

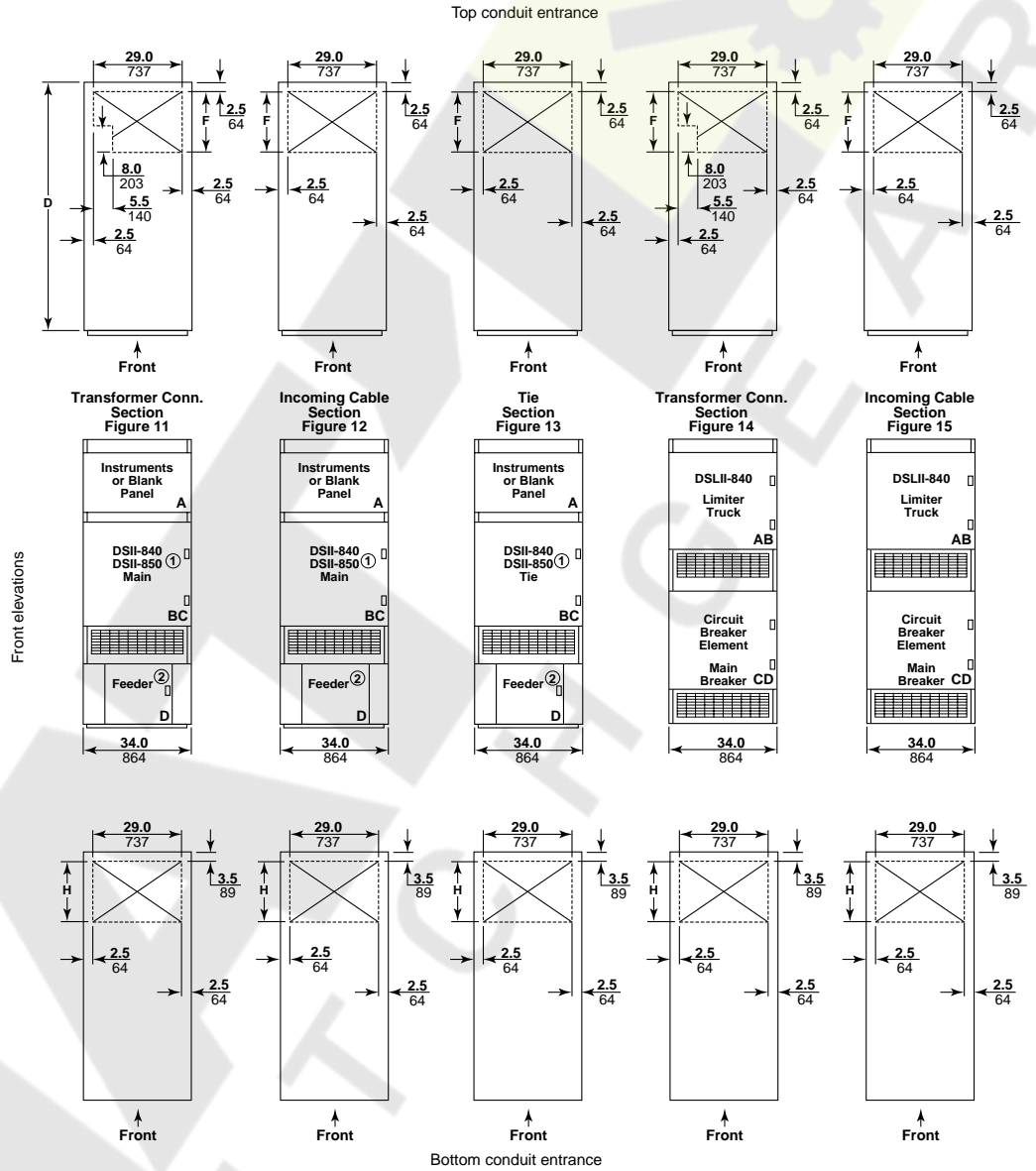

- ① DS-850 - Forced air cooled.
- ② No feeder permitted with DS-850.

6035-12



Dimensions

Indoor Construction

Approximate Dimensions – Not for Construction

Bus Size	Circuit Breaker Type	Section Depth D		Figure 1,1A Transition Aux. Unit				Figure 2 Incoming Unit/ 4 High for Unit				Figure 3 Transformer Main Unit				Figure 4 Tie Unit			
				IN		MM		IN		MM		IN		MM		IN		MM	
		IN	MM	F	H	F	H	F	H	F	H	F	H	F	H	F	H	F	H
1600 A or 2000 A	DSII	55.13	1400	14.5	13.5	368	343	14.5	6.5	368	165	9.0	6.5	229	165	14.5	6.5	368	165
		60.13	1527	19.5	18.5	495	470	19.5	11.5	495	292	14.0	11.5	356	292	19.5	11.5	495	292
		72.13	1832	31.5	30.5	800	775	31.5	23.5	800	597	26.0	23.5	660	597	31.5	23.5	800	597
1600 A or 2000 A	DSLII	63.13	1604	14.5	13.5	368	343	14.5	6.5	368	165	9.0	6.5	229	165	14.5	6.5	368	165
		68.13	1731	19.5	18.5	495	470	19.5	11.5	495	292	14.0	11.5	356	292	19.5	11.5	495	292
		80.13	2035	31.5	30.5	800	775	31.5	23.5	800	597	26.0	23.5	660	597	31.5	23.5	800	597
3200 A	DSII	55.13	1400	14.5	13.5	368	343	14.5	6.5	368	165	14.5	6.5	368	165
		60.13	1527	19.5	18.5	495	470	19.5	11.5	495	292	19.5	11.5	495	292
		72.13	1832	31.5	30.5	800	775	31.5	23.5	800	597	31.5	23.5	800	597
3200 A	DSLII	63.13	1604	14.5	13.5	368	343	14.5	6.5	368	165	14.5	6.5	368	165
		68.13	1731	19.5	18.5	495	470	19.5	11.5	495	292	19.5	11.5	495	292
		80.13	2035	31.5	30.5	800	775	31.5	23.5	800	597	31.5	23.5	800	597
4000 A 5000 A ⑥	DSII/DSLII (Except DSII/DSLII-840)	63.13	1604	14.5	13.5	368	343a	14.5	6.5	368	165
		68.13	1731	19.5	18.5	495	470a	19.5	11.5	495	292
		80.13	2035	31.5	30.5	800	775a	31.5	23.5	800	597
(See Notes)		→		②,④				②,③				②,③,④				②,③,④			

Bus Size	Circuit Breaker Type	Section Depth D		Figure 5 Cable-in Main				Figure 6 Transformer Main Unit				Figure 7 Tie Unit				Figure 8 Cable-in Main			
				IN		MM		IN		MM		IN		MM		IN		MM	
		IN	MM	F	H	F	H	F	H	F	H	F	H	F	H	F	H	F	H
1600 A or 2000 A	DSII	55.13	1400	14.5	6.5	368	165
		60.13	1527	19.5	11.5	495	292
		72.13	1832	31.5	23.5	800	597
1600 A or 2000 A	DSLII	63.13	1604	14.5	6.5	368	165
		68.13	1731	19.5	11.5	495	292
		80.13	2035	31.5	23.5	800	597
3200 A	DSII	55.13	1400	9.0	6.5	229	165	14.5	6.5	368	165	...	6.5	...	165
		60.13	1527	14.0	11.5	356	292	19.5	11.5	495	292	19.5	11.5	495	292
		72.13	1832	26.0	23.5	660	597	31.5	23.5	800	597	31.5	23.5	800	597
3200 A	DSLII	63.13	1604	14.5	6.5	368	165
		68.13	1731	19.5	11.5	495	292
		80.13	2035	31.5	23.5	800	597
4000 A 5000 A ⑥	DSII/DSLII (Except DSII/DSLII-840)	63.13	1604	14.5	6.5	368	165
		68.13	1731	19.5	11.5	495	292
		80.13	2035	31.5	23.5	800	597
(See Notes)		→		②,④				②,③				②,③,④				②,③,④			

NOTE: Conduit areas are for mechanical connectors. For compression lug conduit area, consult your local Square D sales office.

- ① Transformer or auxiliary Unit Fig. 1A only.
- ② Conduit area for bottom (H) increases by 7 in/177.8 mm when there is no circuit breaker in the bottom cell.
- ③ When a bus duct is used in this unit the top entrance (F) is decreased, consult your local Square D sales office for area.
- ④ Service entrance barrier and other barriers change conduit area, consult your local Square D sales office for area.
- ⑤ This unit has a through bus connection. For a 'CD' feeder, consult your local Square D sales office.
- ⑥ 5000 A applications, consult your local Square D sales office.



Dimensions

Dimensions

Indoor Construction

Approximate Dimensions – Not for Construction

Bus Size	Circuit Breaker Type	Section Depth D		Figure 9 Transformer Main				Figure 10 Cable-in Main				Figure 11 Transformer Main Unit				Figure 12 Cable-in Main				
				IN		MM		IN		MM		IN		MM		IN		MM		
		IN	MM	F	H	F	H	F	H	F	H	F	H	F	H	F	H	F	H	
		63.13	1604	9.0	8.75	229	222	
3200 A	DSLII	68.13	1731	14.0	13.75	356	349	19.5	13.75	495	349	
		80.13	2035	26.0	25.75	660	654	19.0	25.75	483	654	
	DSII/DSLII	63.13	1604	6.5	...	165	
4000 A	840	68.13	1731	6.5	11.5	165	292	19.5	11.5	495	292
5000 A [ⓐ]	DSII-850	80.13	2035	18.5	23.5	470	597	31.5	23.5	800	597
(See Notes)		→		③,⑤				③,④				②,③				②,④				

Bus Size	Circuit Breaker Type	Section Depth D		Figure 13 Tie Unit				Figure 14 Transformer Main				Figure 15 Cable-in Main							
				IN		MM		IN		MM		IN		MM					
		IN	MM	F	H	F	H	F	H	F	H	F	H	F	H				
		63.13	1604
3200 A	DSLII	68.13	1731
		80.13	2035
	DSII/DSLII	63.13	1604	14.5	6.5	368	165	...	8.5	...	216	
4000 A	840	68.13	1731	19.5	11.5	495	292	6.5	12.5	165	317	19.5	13.75	495	349	
5000 A [ⓐ]	DSII-850	80.13	2035	31.5	23.5	800	597	18.5	24.5	470	622	19.0	17.75	483	451	
(See Notes)		→		②,③,④				③				③,④							

NOTE: Conduit areas are for mechanical connectors. For compression lug conduit area, consult your local Square D sales office.

- ① Transformer or auxiliary Unit Fig. 1A only.
- ② Conduit area for bottom (H) increases by 7 in/177.8 mm when there is no circuit breaker in the bottom cell.
- ③ When a bus duct is used in this unit the top entrance (F) is decreased, consult your local Square D sales office for area.
- ④ Service entrance barrier and other barriers change conduit area, consult your local Square D sales office for area.
- ⑤ This unit has a through bus connection. For a 'CD' feeder, consult your local Square D sales office.
- ⑥ 5000 A applications, consult your local Square D sales office.

Type of Device	Lb	Kg	Type of Device	Lb	Kg
DSII-308 Circuit Breaker	175	79.4	DSII-850 Circuit Breaker	405	184.1
DSII-508 Circuit Breaker	180	81.7	DSLII-308 Circuit Breaker	205	93.0
DSII-608 Circuit Breaker	180	81.7	DSLII-516 Circuit Breaker	255	115.7
DSII-516 Circuit Breaker	180	81.7	DSLII-632 Limiter Truck	325	147.4
DSII-616 Circuit Breaker	185	83.9	DSLII-840 Limiter Truck	430	195.0
DSII-620 Circuit Breaker	180	81.7	4-high unit without Circuit Breakers (22")	1600	725.8
DSII-632 Circuit Breaker	300	136.0	Unit without Circuit Breakers (34")	2600	1179.3
DSII-840 Circuit Breaker	405	184.1	Auxiliary unit without devices	500	226.8

Recommended Minimum Clearance:
 Front - 42" (1050 mm)
 Rear - 42" (1050 mm)
 Ref. NEC®, Article 110-16



General

The specifications and associated drawings describe the indoor low voltage metal-enclosed drawout switchgear assembly. The assembly is to be designed for use on a _____ volt, (single) (3) phase, _____ wire, 50/60 Hz system, with _____ amperes symmetrical fault current available. Equipment is to be complete from the incoming line connections to the outgoing feeder connections. Any items not specifically mentioned but obviously necessary for proper operation are implied in this description.

The low voltage section shall be POWER-ZONE III Series 2 low voltage, metal-enclosed switchgear, as manufactured by the Square D company, or approved equal, designed, manufactured, and tested in accordance with applicable standards for power circuit breakers and metal-enclosed switchgear.

Applicable Standards:

Structures:	Circuit Breakers:
NEMA SG5	NEMA SG3
ANSI C37.20.1	ANSI C37.13
ANSI C37.51	ANSI C37.16
UL 1558 (Optional)	UL 1066 (Optional)

The enclosure shall be electro-deposition coated with medium gray ANSI #49 enamel applied over a rust inhibiting phosphate primer. (Equipment shall be equipped with Service Entrance Label) (and (UL 1558 label for metal-enclosed low voltage power circuit breaker type switchgear assemblies when UL recognized components are specified.)

Enclosure

The enclosure and internal barriers shall be fabricated of steel members in accordance with NEMA and ANSI standards. Steel lifting straps are to be provided with each shipping group to lift the structure from the top with a crane. Supply a wooden skid to permit the use of pipe rollers for moving the switchgear to its final location in the building.

All vertical sections shall be bolted together. Ventilation openings on the front of the switchgear breaker compartments are to be located in such a way as to preclude the possibility of metal objects being inserted through them and easily contacting energized parts. To barrier operator from escaping gases during an interruption, circuit breakers shall be supplied with a steel front plate when ventilation openings are on the front of the circuit breaker compartment door.

The equipment shall be assembled, adjusted, and tested at the factory and shall be sectionalized, if required, for shipping as requested or approved. The largest section is not to exceed ____ inches wide, ____ inches deep, and ____ inches high to enable installation at the job site.

The structure is to consist of three basic compartments from the front to the rear: the front circuit breaker compartment, the center bus compartment, and the rear cable compartment.

Front Circuit Breaker Compartment

The front circuit breaker compartment is to contain the drawout circuit breaker elements, each mounted in its own barriered cell. Fully prepared cells shall be equipped to accept circuit breaker drawout mechanism and contain all secondary and primary current-carrying parts. Future use cells shall contain current carrying parts only and shall be capable of being converted by authorized personnel to accept a drawout circuit breaker and control circuits. Provide each circuit breaker cell and fully prepared cell with a hinged door equipped with a flush handle and an external trip button. When equipped with a circuit breaker, a double steel barrier shall exist between operating personnel, the circuit breaker mechanism, and the live parts. Thus, the circuit breaker can be operated with the outer steel door open.

If the circuit breaker protrudes through a hole in the circuit breaker compartment door, shutters shall be provided to shield live parts when the circuit breaker is out for service. Also, a steel plate shall be provided for the opening in the circuit breaker compartment door to preclude the possibility of foreign objects entering the circuit breaker cell when the circuit breaker is removed.



Suggested Specifications

Center Bus Compartment

The bus compartment is to contain the section riser and main cross bus, which is to be rated for a 65 °C temperature rise per ANSI standards. The main cross bus shall be rated for ___ continuous amperes. All main and riser bus shall be bolted copper and adequately braced so to be applied on a system capable of supplying RMS symmetrical amperes of short circuit current of 50 kA, (100 kA), (150 kA), (200 kA).

All contact surfaces at bolted joints shall be fully silver plated and the joint bolts are to be of high strength grade 5 steel equipped with conical type spring washers. Riser bus shall meet industry standard phase-to-phase clearance without the use of insulated/isolated bus. All electrical clearances are to be for 600 Vac. (An isolated neutral bus is to be supplied rated at (50) – (100) percent of the phase current.)

Rear Cable Compartment

Size the cable compartment to accommodate all incoming and outgoing cable required within each vertical switchgear section. Cable lugs are to be mounted on the load side (or line side as applicable) run-back bus, which is extended into this compartment from the bus compartment. Run-back bus for main or feeder circuit breakers are to be insulated from the section riser and the cross bus. This compartment shall also contain a copper ground bus bolted directly to the switchgear frame. (Extend a neutral run-back into the cable compartment for connecting the neutral to the ground bus with a removable isolating link.) (Clamp-type cable lugs suitable for use with aluminum or copper cable are to be supplied as shown on the plans.)

(Option 1)

The center bus compartment containing the section riser bus and main cross bus shall be segregated from the rear cable compartment by means of grounded metal barriers. Using plastic covers over bus, in lieu of rear barriers, for this safety precaution is not acceptable.

Circuit Breakers

The circuit breakers shall be the drawout type, manually or electrically operated Type DSII (DSLII) as shown on the associated drawings or as listed in the equipment tabulation. The circuit breakers are to mount on a rigid self-aligning drawout mechanism with “connected”, “test”, “disconnected”, and “removed” positions. The front door shall be capable of being closed in the “connected”, “test”, or “disconnected” positions. Provide interlocks to ensure the circuit breaker is open before it can be moved from any position or when it is between positions. Include an interlock to discharge the stored energy spring before the circuit breaker element can be withdrawn from its cell. In the “test” and “connected” positions, provide a positive ground contact between the circuit breaker element and the structure.

Circuit Breakers of like frame sizes shall be interchangeable as standard. No special structural bracing will be required. All circuit breaker operating mechanisms are to be fully stored energy devices with a two-step stored energy quick-make, quick-break. Actuation of the operating handle or an operation cycle of the circuit breaker motor is to charge the closing springs. Operation of a local “close” button is to close the circuit breaker contact. Closing of the circuit breaker contacts shall automatically charge the opening springs to ensure quick-break operation.

Low voltage power circuit breaker arc chutes containing asbestos will by no means be accepted.

(Circuit breakers of 5000 A frame size may be forced air cooled.)

The circuit breaker trip device is to be of a microprocessor design, which requires no external power connections, and provided with an adjustable long-time delay, instantaneous (and short-time delay) over-current/short circuit protection. (Include ground fault tripping as an integral part of the microprocessor trip device.) Internal self-testing of the unit shall be provided. Indicators for overload, short circuit, and ground trip shall be provided. (Circuit breakers are to have UL label.)



(The trip unit shall be capable of measuring AC phase currents, power, energy, trip level, and show cause of trip. The trip unit shall be able to communicate this information, as well as permit remote operation of the circuit breaker, via the Square D POWERLOGIC communications network.)

Padlocking provisions shall be furnished to receive up to three padlocks when circuit breaker is in the open position, positively preventing unauthorized closing of the circuit breaker contacts. A manual trip button and position indicator shall be furnished on all circuit breakers. A "Push to Close" button shall be conveniently located on face of circuit breaker for easy access, thereby avoiding the need to reach behind or around other devices located on the face of the circuit breaker.

(Include the following only when Type DSLII circuit breakers are specified:)

(Circuit breakers shall be equipped with current limiters. Current limiters shall be integrally mounted on 800 A and 1600 A frame sizes and separately mounted on 3200 A and 4000 A frame sizes. Equip each circuit breaker with a blown limiter indicator visible from the front of the circuit breaker, and with an anti-single phase device that will trip the circuit breaker when any limiter blows and will prevent reclosing the circuit breaker on a single phase condition resulting from blown or missing limiters.)

The following equipment shall be provided:

- (1)(2) _____ Type DSII- _____ main circuit breaker(s), _____ ampere frame, 3-pole, (manually) (electrically) operated. Long-time Trip rated _____ amperes.
- _____ Type DSII- _____ tie circuit breaker, _____ ampere frame, 3-pole, (manually) (electrically) operated. Long-time Trip rated _____ amperes.
- _____ Type DSII- _____ feeder circuit breaker(s), _____ ampere frame, 3-pole, (manually) (electrically) operated. Long-time Trip rated _____ amperes.
- _____ Type DSII- _____ feeder circuit breaker(s), _____ ampere frame, 3-pole, (manually) (electrically) operated. Long-time Trip rated _____ amperes.

Metering Components

Main Bus

- (1)(2) _____ POWERLOGIC (circuit monitor model *) (Power meter model *)
- _____ Current transformer, suitable ratio.
- _____ Potential transformer, suitable ratio.

Feeder Circuits

- _____ POWERLOGIC (circuit monitor model *) (Power meter model *)
- _____ 2% ammeter and 3-phase selector switch with OFF position.
- _____ Current transformer, suitable ratio.

(Option 2)

A portable testing device shall be provided.

(Option 3)

A top mounted traveling circuit breaker lifting device shall be provided.

() Indicates a selection is to be made for quantity or applicability.

* (A complete line of POWERLOGIC circuit monitors, power meters, and control systems is available for POWER-ZONE III switchgear. Consult your local Square D sales office.)



Suggested Specifications

For further information about POWER-ZONE III Series 2 Switchgear, contact your local Square D field sales office. They are conveniently located in over 160 cities throughout the U.S. and abroad to serve you: or, write to LV Equipment Product Marketing Section, Square D Company, 1010 Airpark Center Drive, Nashville, TN 37217







Trademark Acknowledgements

The following trademarks or registered trademarks are the property of the indicated entities.

American National Standards Institute

ANSI

Cutler-Hammer Corporation

DIGITRIP

National Fire Protection Association

National Electrical Code, NEC

National Electrical Manufacturers' Association

NEMA

Square D Company

SQUARE D, POWER-ZONE, POWERLOGIC, 

Underwriter's Laboratories

UL

Square D Company
1500 South University Blvd.
Middletown, OH 45044
(513) 424-1601
www.squared.com

6035CT9201 11/98 November 1998 © 1998 Square D All Rights Reserved.
Replaces 6035CT9201 dated 7/94.